



# GeKaMac®



## **PoWerTech 4000 Vision Pulse Users Manual**

Please Read and Understand This Manual  
Before Operating The Welding Machine

[www.gedikwelding.com](http://www.gedikwelding.com)

This machine is for internal use only.

It complies with the WEEE Directive.

This machine has been designed in accordance with the EN 60974-1 and EN 60974-10 standards.

The machine is safe when installation, operation, and maintenance are performed in accordance with the user manual and regulations. The operator and machine owner are responsible for adhering to safety rules.

Gedik Kaynak San. Ve Tic. A.Ş. assumes no responsibility for safety or CE compliance if any modifications are made to the machine or if safety rules are not followed.



**This Class A equipment is not suitable for use in homes and similar residential areas where the power supply is provided by the low-voltage public electricity network.**



This machine is not household waste and cannot be disposed of in the trash.

When the machine reaches the end of its service life or becomes obsolete, it must be disposed of in accordance with regulations.

**COMPLIES WITH THE WEEE DIRECTIVE.**

### **Eco Design Statement**

This machine has been designed and manufactured in accordance with the requirements of the 2009/125/EC Eco Design Directive concerning the environmentally friendly design of energy-related products.

Accordingly, machines with an idle mode are as follows.

	<b>Idle Mode</b>
<b>MMA</b>	<b>X</b>
<b>MIG</b>	√
<b>TIG</b>	√
<b>Plazma</b>	√
<b>SAW</b>	<b>Out of Scope</b>

**Efficiency measurements should be conducted only on the power unit. The water cooling system should be disabled. For more information on measurements and machine settings, Gedik Kaynak Sanayi ve Ticaret A.Ş. should be consulted.**

**AT UYGUNLUK BEYANI****EU DECLARATION OF CONFORMITY**

Bu uygunluk beyanı yalnızca imalatçının sorumluluğu altında düzenlenir.

This declaration of conformity is issued under the sole responsibility of the manufacturer.

İstanbul, Turkey, 08.03.2024

**İmalatçı / Manufacturer**

GEDİK KAYNAK SANAYİ ve TİCARET A.Ş.

Ankara Cad. No.306 Seyhli Pendik İSTANBUL TÜRKİYE

**Ürün / Product**

ARC WELDING MACHINE

**Marka-Model / Brand- Model**

POWER TECH 4000 VISION PULSE

Yukarıda tanımlanan beyanın nesnesi ilgili uyumlaştırılmış AB mevzuatı ile uyumludur.

The object of the declaration described above, is in conformity with the relevant union harmonisation legislation.

**Direktifler / Directives**

2014/30/EU & 2014/35/EU & 2009/125/EC  
EU/2019/1784

Uyumlaştırılmış standartlar ve uygunluğun deklare edilmesiyle ilişkili diğer referanslar.

References to the relevant harmonised standarts used and references to the other technical specifications in relation to which conformity is declared.

**Standartlar / Standards**

EN IEC 60974-1  
EN IEC 60974-10

Bu ekipman, talimatlara uygun kurulduğunda, bakımı yapıldığında ve kullanıldığında belirtilen standartlara uygundur. Makine üzerinde bir değişiklik yapıldığında veya yanlış kullanımda deklarasyon geçersiz olur.

The equipment is in compliance with pertinent legislation when installed, utilized, and maintained in accordance with the enclosed instructions. This declaration will be invalid under any modification or improper use.

**İmalatçı Adına İmzalayan / Signed for and on behalf of:**

Hatice Özel, Equipment Business Unit Director



Introduction	2
Description	2
Operating features	2
Technical data	3
Usage limits (IEC 60974-1)	3
How to lift up the system	4
Opening the packaging	4
Installation and connections	4
Connection to the electrical supply	4
Usage norms	4
MIG-MAG / PULSE MIG / DOUBLE PULSE MIG Welding	5
Spot welding	7
Interval welding	7
Aluminium welding	7
Electrode welding (MMA)	7
TIG welding with "Lift"	8
Maintenance	8
Optional	9
The pointing out of any difficulties and their Elimination	
Replacing the digital interface PCB	9
Meaning of graphic symbols on machine	11
Wiring diagram	10
Key to the electrical diagram	11
Spare Parts Limits	5

## Introduction

Thank you for buying our product.

In order to get the best performance out of the plant and ensure the maximum lifespan of its parts, the use and maintenance instructions contained in this manual must be read and strictly complied with, as well as **the safety instructions contained in the relevant folder**. If repairs to the plant are required, we recommend that our clients contact our service centre workshops, as they have the necessary equipment and personnel that are specifically trained and constantly updated.

All our machines and equipment are constantly developed and so changes may be made in terms of their construction and features.

## Description

### MULTI-FUNCTION INVERTER GENERATOR FOR MIG-MAG, MMA, and TIG WELDING

The **DIGITECH vision PULSE** series of multi-function equipments are characterised by cutting edge, attractive design combined with latest generation inverter technology and digital welding control. Innovative, technologically advanced, robust, and easy to use, they can be used for very high quality MIG-MAG and Pulse MIG welding for all materials and especially stainless steel and aluminium, reducing repeat work due to spray to a minimum, using electrodes, and in TIG with "Lift" type ignition, and they represent the best solution for all industrial fields and all specialist welding purposes that call for high precision and repeatable results. **DIGITECH vision PULSE** equipments, fitted with an innovative synergic digital control, colour display, and the extraordinary VISION-ARC meet the needs of those that wish to combine synergy with complete control of all welding parameters.

They come in a version with a separate feeder (Wire Feeder). These are systems open to the future evolution of technology - the control software can be kept up to date with the latest versions with the help of a personal computer.

## Operating features

The main feature of the welding unit **PoWerTech 4000/5000 Vision Pulse** are:

- Metallic main structure with shockproof plastic front frames.
- Controls protected by a visor.
- Spatter free exceptional welding characteristics in both MIG/MAG, MIG Pulsed and MIG Dual Pulsed on any material and with any gas.
- High welding performance in both MMA and TIG by "Lift" mode striking.
- Synergic digital control (DH) of all welding parameters, displayed via the innovative colour display, also featuring the following functions:
  - Allows less expert operators to regulate all welding parameters in a user-friendly way and extremely easily, choosing the type of program on the basis of the material, wire diameter, and gas used.
  - Innovative "VISION ARC" software for controlling all welding parameters.
  - With the special MIG torches you can adjust the welding parameters at a distance straight from the torch.
  - BURN BACK control. At the end of each weld, in any condition and with any material, the digital control ensures a perfect wire cut, prevents the typical "wire globule" from forming and ensures correct arc restriking.
  - WSC Wire start control. This arc striking control device prevents wire from sticking to the workpiece or torch nozzle

and ensures precise and smooth arc striking, particularly when welding aluminium.

- Welding parameters that are controlled digitally by a micro-processor, are monitored and modified in just a few seconds, maintaining a consistently precise and stable arc as the welding conditions continue to vary due to the movement of the torch and the irregularities of the parts to be welded.
- Exclusive SWS “Smart Welding Stop” system at the end of TIG welding. Lifting up the torch without switching off the arc will introduce a slope down and it will switch off automatically.
- “Energy Saving” function to operate the power source cooling fan and the torch water cooling only when necessary.
- Auto-diagnostic feature for trouble shooting.
- Password-controlled total or partial equipment access.
- High electrical performance resulting in a reduction in energy consumption.
- Remote parameter adjustment directly from Wire feeder.

## Technical data

The general technical data of the system are summarized in table 1.

## Usage limits (IEC 60974-1)

The use of a welder is typically discontinuous, in that it is made up of effective work periods (welding) and rest periods (for the positioning of parts, the replacement of wire and underflushing operations etc. This welder is dimensioned to supply a  $I_2$  max nominal current in complete safety for a period of work of 40/50% of the total usage time. The regulations in force establish the total usage time to be 10 minutes. The work cycle is considered to be 40/50% of this period of time. Exceeding the work cycle allowed could cause a trip switch to trip (for further information see the DH control panel manual), which protects the components inside the welding machine against dangerous overheating. After several minutes the overheat cut-off rearms automatically and the welder is ready for use again.

Table 1

Model	PoWerTech 4000 Vision Pulse		PoWerTech 5000 Vision Pulse
	MIG-MAG welding		
Three-phase input 50/60 Hz	V	400 ± 20%	400 ± 20%
Mains supply: $Z_{max}$	$\Omega$	0,028	0,017
Input power @ $I_2$ Max	kVA	25,5	32
Delayed fuse ( $I_2$ @ 60%)	A	30	40
Power factor / $\cos\phi$		0,66 / 0,99	0,66 / 0,99
Efficiency degree	$\eta$	0,86	0,89
Open circuit voltage	V	70	70
Current range	A	10 ÷ 400	10÷500
Duty cycle @ 100% (40°C)	A	330	380
Duty cycle @ 60% (40°C)	A	370	460
Duty cycle @ X% (40°C)	A	400 (50%)	500 (50%)
Wires diameter (*)	mm	0,6 ÷ 1,6 (*)	0,6 ÷ 1,6 (*)
N° rollers (*)		4 (*)	4 (*)
Power output of feeder motor (*)	W	100 (*)	100 (*)
Rated wire feeding speed (*)	m/min	0,5 ÷ 25 (*)	0,5 ÷ 25 (*)
Spool (*)			
Diameter	mm	Ø300 (*)15 (*)	Ø300 (*)15 (*)
Weight	kg		
Standards		IEC 60974-1 - IEC 60974-5 (*) - IEC 60974-10 (49)	
Protection class		IP 23 S	IP 23 S
Insulation class		H	H
Dimensions	mm	660 - 515 - 290	660 - 515 - 290
Weight	kg	40	44

(\*) On the Wire feeder, fitted separately.

**WARNING:** This equipment complies with **EN/IEC 61000-3-12** provided that the maximum permissible system impedance  $Z_{max}$  is less than or equal to 0,037  $\Omega$  PoWerTech 4000 Vision Pulse - 0,017  $\Omega$  PoWerTech 5000 Vision Pulse at the interface point between the user's supply and the public system. It is the responsibility of the installer or user of the equipment to ensure, by consultation with the distribution network operator if necessary, that the equipment is connected only to a supply with maximum permissible system impedance  $Z_{max}$  less than or equal to 0,037  $\Omega$  PoWerTech 4000 Vision Pulse - 0,017  $\Omega$  PoWerTech 5000 Vision Pulse

This system, tested according to **EN/IEC 61000-3-3**, meets the requirements of **EN/IEC 61000-3-11**.

## How to lift up the system

Strap the system safely and securely in the slings working from the bottom, then lift up from the ground.

This welding machine has a robust handle built into the frame for moving the equipment.

**NOTE:** *These hoisting and transportation devices conform to European standards. Do not use other hoisting and transportation systems.*

## Opening the packaging

The system essentially consists of:

- **PoWerTech 4000/5000 Vision Pulse** weld unit.
- Separately:
  - wire-feeder unit (supplied separately).
  - MIG-MAG welding torch (optional).
  - Wire-feeder/generator interconnection cable (supplied separately).
  - Coolant unit for welding torch (optional).
  - Trolley to carry it around (optional).

Perform the following operations on receiving the apparatus:

- Remove the welding generator and all accessories and components from the packaging.
- Check that the welding apparatus is in good condition; otherwise immediately inform the retailer or distributor.
- Check that all the ventilation grilles are open and that there is nothing to obstruct the correct air flow.

## Installation and connections

The installation site for the system must be carefully chosen in order to ensure its satisfactory and safe use. The user is responsible for the installation and use of the system in accordance with the producer's instructions contained in this manual. Before installing the system the user must take into consideration the potential electromagnetic problems in the work area. In particular, we suggest that you should avoid installing the system close to:

- Signalling, control and telephone cables.
- Radio and television transmitters and receivers.
- Computers and control and measurement instruments.
- Security and protection instruments.

Persons fitted with pace-makers, hearing aids and similar equipment must consult their doctor before going near a machine in operation. The equipment's installation environment must comply to the protection level of the frame.

The welding unit is characterized by the following classes:

- IP 23 S protection class indicates that the generator can be used in both interior and exterior environments.
- The "S" usage class indicates that the generator can be employed in environments with a high risk of electrical shocks. This system is cooled by means of the forced circulation of air, and must therefore be placed in such a way that the air may be easily sucked in and expelled through the apertures made in the frame.

Assemble the system in the following way:

- Assemble the trolley.
- Fixing the cooling unit to the trolley.
- Fixing of the welding machine to the trolley and the cooling unit (electrical and plumbing connections).
- Fitting the feeder unit to the generator.
- Connect up the welder to the mains.
- Connect up the wire-feeder/generator interconnection cable.
- Connect up the welding cables.

Instructions for fitting the individual components / optional extras are contained in the relevant packaging.

## Connection to the electrical supply

**Connection of the machine to the user line (electrical current) must be performed by qualified personnel.**

**Before connecting the welding machine to the mains power supply, make sure that rated voltage and frequency correspond to those provided by the mains power supply and that the welding machine's power switch is turned to "O".**

Use the welder's own plug to connect it up to the main power supply. Proceed as follows if you have to replace the plug:

- 3 conducting wires are needed for connecting the machine to the supply.

**Connect a suitable load of normalised plug (3P+T) to the power cable and provide for an electrical socket complete with fuses or an automatic switch. The ground terminal must be connected to the ground conducting wire (YELLOW-GREEN) of the supply.**

Table 2 shows the capacity values that are recommended for fuses in the line with delays.

**NOTE:** *Any extensions to the power cable must be of a suitable diameter, and absolutely not of a smaller diameter than the special cable supplied with the machine.*

## Usage norms

### CONTROL APPARATUS (Fig. A)

- Pos. 1** "DH" control panel.
- Pos. 2** Fast coupling positive polarity.
- Pos. 3** Fast coupling negative polarity.
- Pos. 4** Mains switch. In the "O" position the welder is off.
- Pos. 5** Connector for connecting the interconnection cable or auxiliary welding controls.
- Pos. 6** Fast coupling reverse polarity.
- Pos. 7** Connector for connecting the cooling system.
- Pos. 8** Mains cable.

Table 2

Model		PoWerTech 4000 Vision Pulse	PoWerTech 5000 Vision Pulse
		MIG-MAG welding	
Input power @ I <sub>2</sub> Max	V	25,5	32
Delayed fuse (I <sub>2</sub> @ 60%)	Ω	30	40
Duty cycle @ X% (40°C)	kVA	400 (50%)	500 (50%)
Mains cable			
Length	mm	4,5	4,5
Section	kg	4 × 4	4 × 6
Ground cable	kg	50	70



FIG. A

**MIG-MAG / PULSE MIG / DOUBLE PULSE MIG Welding**

To begin MIG-MAG / PULSE MIG / DOUBLE PULSE MIG welding, carry out the following tasks (with the machine switched off).

**1 - Connecting the gas hose and torch (Fig. B1-B2)**

- Connect the gas hose to the pressure reducer fitted on the cylinder beforehand.
- Screw the torch onto the centralised connection on the front panel of the feeder and connect the feed (blue) and return (red) water hoses for cooling the torch to the respective (blue and red) rapid couplings on the front panel of the feeder.

**2A - Connecting the cables - Welding with a POSITIVE POLE TORCH (Fig. B1)**

- 1) The feeder - generator connecting cable is used to connect the welding machine to the feeder.

**WARNING:** Do not disconnect the wire-feeder until the machine has been switched off.

Connect up the interconnection cables (power cable, ancillary wiring and gas tube) to the special attachments and couplings shown in Fig. B1.

The delivery (blue coloured) and return (red coloured) water tubes, used for cooling the torch of the welding machine, are part of the interconnection cable and should be connected as follows:

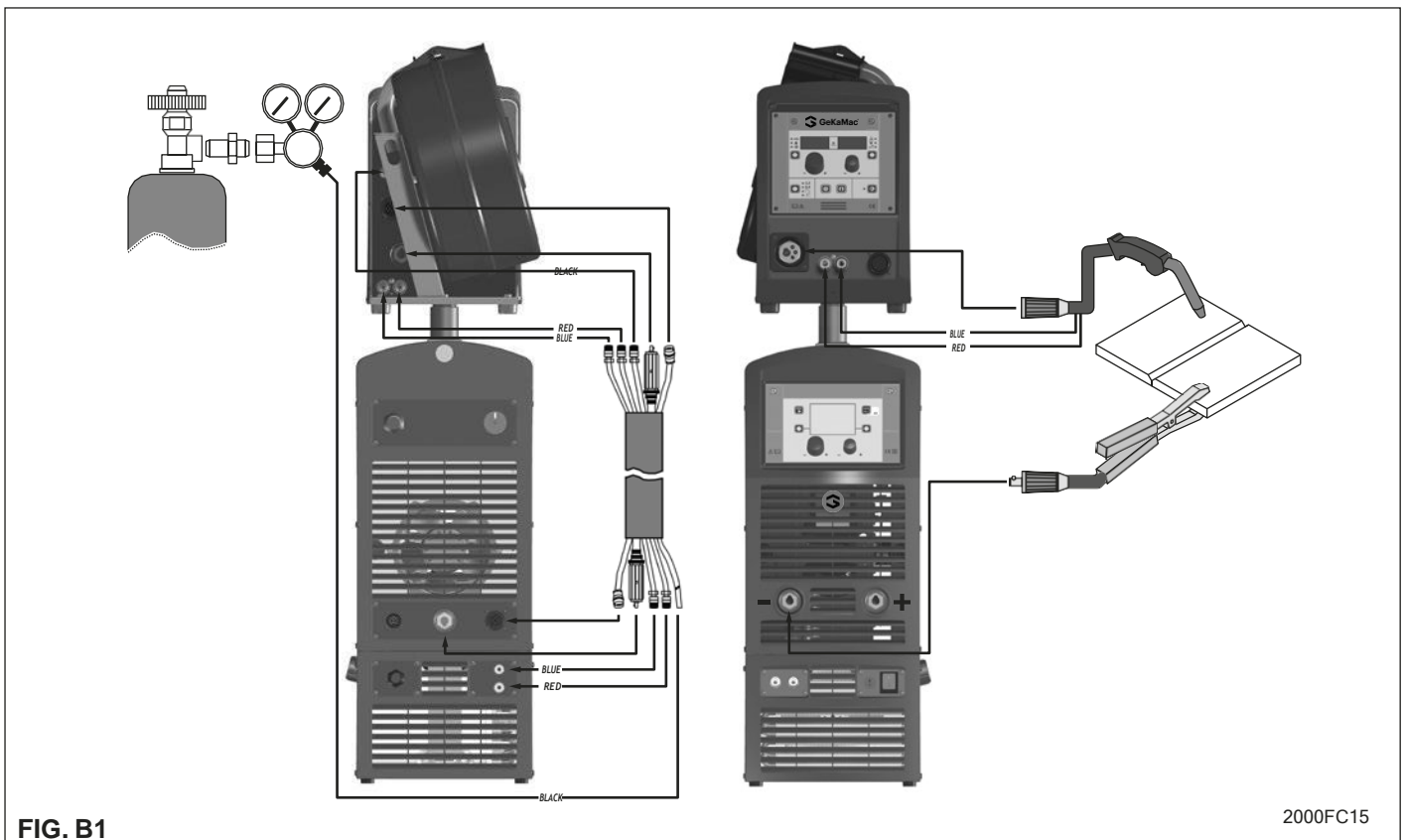

FIG. B1

2000FC15

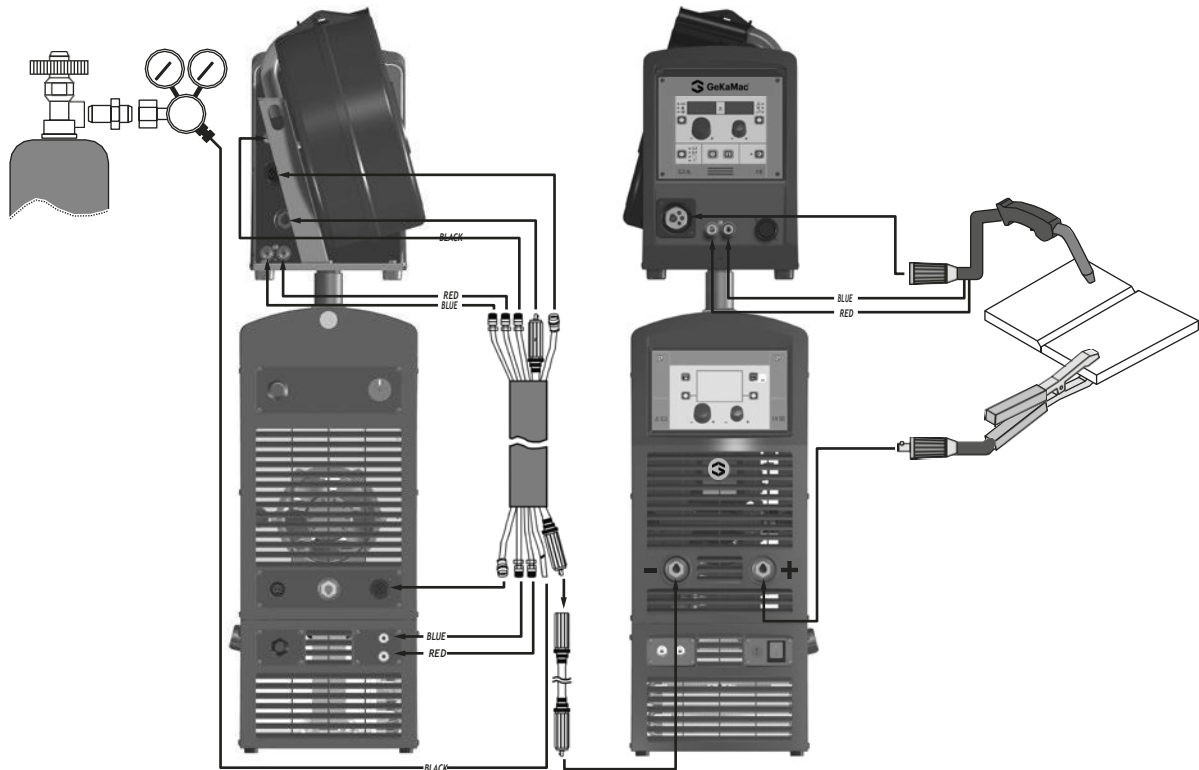

FIG. B2

2000FC16

- Interconnection cable on generator side: connect up tubes to their rapid couplings (blue and red coloured) at the back of the coolant system.
  - Wire feeder side connecting cable: connect the red and blue pipes to their respective bulkhead grommets on the rear panel of the feeder.
- 2) Connect up the earthing system cable to the rapid coupling marked by a - (negative) symbol and then the relevant ground clamps to the piece being welded or to its support in an area free from rust, paint and grease. Using particularly long earthing cables reduces the voltage and causes some problems from increased resistance and inductance of the cables that could cause faulty welding. Follow instructions to avoid these problems:
- Use earthing and extension cables with appropriate section.
  - Lay out the cables as a flat as possible to prevent them from coiling up.

## 2B - Connecting the cables - Welding with a NEGATIVE POLE TORCH (Fig. B2)

- 1) Connect the generator - feeder connection cable using the extension cable in addition to invert the polarity (optional).

**WARNING:** Do not disconnect the wire-feeder until the machine has been switched off.

Connect up the interconnection cables (power cable, ancillary wiring and gas tube) to the special attachments and couplings shown in Fig. B2.

The delivery (blue coloured) and return (red coloured) water tubes, used for cooling the torch of the welding machine, are part of the interconnection cable and should be connected as follows:

- Interconnection cable on generator side: connect up tubes to their rapid couplings (blue and red coloured) at the back of the coolant system.

- Wire feeder side connecting cable: connect the red and blue pipes to their respective bulkhead grommets on the rear panel of the feeder.
- 2) Connect up the earthing system cable to the rapid coupling marked by a + (positive) symbol and then the relevant ground clamps to the piece being welded or to its support in an area free from rust, paint and grease. Using particularly long earthing cables reduces the voltage and causes some problems from increased resistance and inductance of the cables that could cause faulty welding. Follow instructions to avoid these problems:
- Use earthing and extension cables with appropriate section.
  - Lay out the cables as a flat as possible to prevent them from coiling up.

## 3 - Welding

- 1) Switch the welding machine on by moving the power supply switch to I (Pos. 4, Fig. A).
- 2) Make the adjustments and do the parameter settings on the control panel (for further information see the DH control panel manual).
- 3) Load the wire (see the relevant paragraph in the feeder manual) using the motor test button, after having removed the wire guide nozzle from the torch to allow the wire to come out freely during loading (remember that the wire guide nozzle must correspond to the diameter of the wire used).
- 4) Open the tap on the cylinder slowly and adjust the reducer knob to obtain a pressure of about 1,3 to 1,7 bar, and then activate the gas test button and regulate the flow to a value between 14 and 20 lit/min to suit the current used for welding.
- 5) The welding machine is ready to weld. Make the adjustments and select the parameters for the feeder or, if selected, on the control panel (for further information see the DH control panel manual). Start welding by moving close to the welding point and press the torch button.



- 6) Once welding has been completed remove any slag, switch off the machine (which is only to be done when the fan is not running), and close the gas cylinder.

## Spot welding

The substantial difference with MIG-MAG welding is essentially related to the torch and the adjustments that must be made on the DH control panel.

- The gas guide nozzle specifically for spot welding must be fitted on the torch (see Fig. C).
- On the DH control panel, select the spot welding mode and set the time.

To begin spot welding:

- Press the torch button to start the welding current and wire feed.
- When the spot welding time expires, the wire feed stops automatically.
- When the torch button is pushed again a new welding cycle starts.
- Release the torch button.

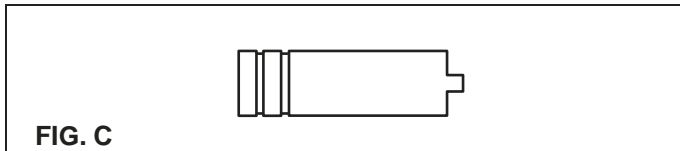

## Interval welding

The basic difference from spot welding is the addition of an additional time known as the “stitch pause”.

On the DH control panel, select the interval welding mode and then set the following times for it:

- Stitch time.
- Stitch pause.

To begin interval welding:

- Press the torch button to start the welding current and wire feed.
- At this point the welding machine automatically carries out a succession of welded portions followed by a pause, according to the times entered previously. This procedure stops automatically only when the torch button is released.
- When the torch button is pushed again the torch begins a new interval welding cycle.

## Aluminium welding

To weld with aluminum wire proceed as follows:

- Replace the drive rolls with special ones for aluminium wire.
- Use a torch with a 3M cable and a carbon Teflon sheath.
- Set the pressure between the drive rollers at the minimum, by turning the screw provided.
- Use argon gas at a pressure of 1,3 - 1,7 bar and regulate the flow to a value between 14 and 20 lit/min to suit the current used for welding.

## Electrode welding (MMA)

On the **PoWerTech 4000/5000 Vision Pulse** machine, electrode welding is used to weld most metals (different types of steel, etc.) using coated rutile and basic electrodes with diameters ranging from Ø 1.6 mm to Ø 6 mm, and devices that the user can adjust for “Arc Force”, “Hot Start”, and Anti-sticking functions to avoid the electrodes sticking.

- 1) Connecting the welding cables (Fig. D):

Disconnect the machine from the mains power supply and connect the welding cables to the output terminals (Positive and Negative) of the welding machine, attaching them to the clamp and ground with the polarity specified for the type of electrode being used (Fig.D). Always follow the electrode manufacturer’s instructions. The welding cables must be as short as possible, they must be near to one

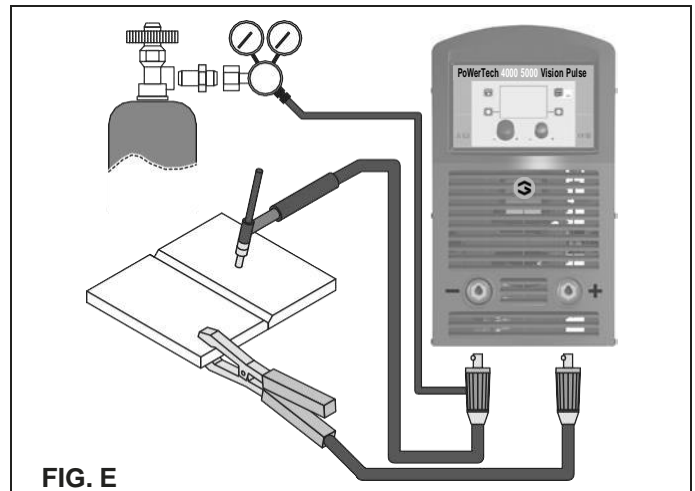
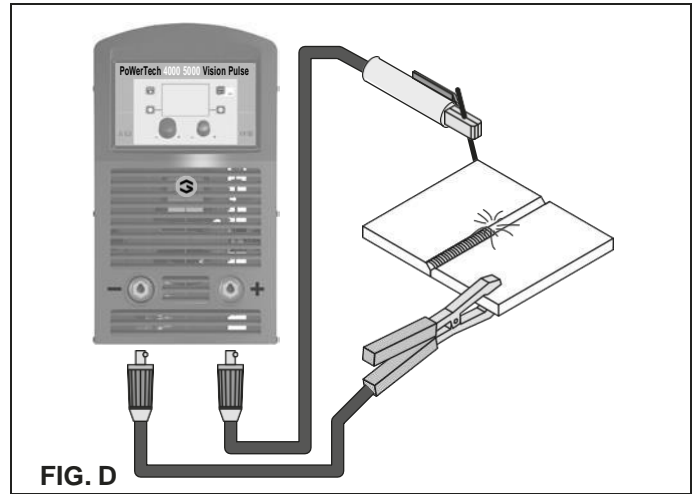

- 2) another, positioned at or near floor level. Do not touch the electrode clamp and the ground clamp simultaneously.
- 2) Switch the welding machine on by moving the power supply switch to I (Pos. 3, Fig. A).
- 3) Make the adjustments and do the parameter settings on the control panel (for further information see the DH control panel manual).
- 4) Carry out welding by moving the torch to the workpiece. Strike the arc (press the electrode quickly against the metal and then lift it) to melt the electrode, the coating of which forms a protective residue. Then continue welding at an inclination of about 60° compared with the metal in relation to the direction of welding.

### PART TO BE WELDED

The part to be welded must always be connected to ground in order to reduce electromagnetic emission. Much attention must be afforded so that the ground connection of the part to be welded does not increase the risk of accident to the user or the risk of damage to other electric equipment. When it is necessary to connect the part to be welded to ground, you should make a direct connection between the part and the ground shaft. In those countries in which such a connection is not allowed, connect the part to be welded to ground using suitable capacitors, in compliance with the national regulations.

### WELDING PARAMETERS

Table 3 shows some general indications for the choice of electrode, based on the thickness of the parts to be welded. The values of current to use are shown in the table 5 with the re-

spective electrodes for the welding of common steels and low-grade alloys. These data have no absolute value and are indicative data only. For a precise choice follow the instructions provided by the electrode manufacturer.

**Table 3**

Welding thickness (mm)	Ø electrode (mm)
1,2 ÷ 2	1,6
1,5 ÷ 3	2
3 ÷ 5	2,5
5 ÷ 12	3,25
≥ 12	4
≥ 20	≥ 5

**Table 4**

Ø electrode (mm)	Current (A)
1,6	30 ÷ 60
2	40 ÷ 75
2,5	60 ÷ 110
3,25	95 ÷ 140
4	140 ÷ 190
5	190 ÷ 240
6	220 ÷ 330

The current to be used depends on the welding positions and the type of joint, and it increases according to the thickness and dimensions of the part.

The current intensity to be used for the different types of welding, within the field of regulation shown in table 4 is:

- High for plane, frontal plane and vertical upwards welding.
- Medium for overhead welding.
- Low for vertical downwards welding and for joining small pre-heated pieces.

A fairly approximate indication of the average current to use in the welding of electrodes for ordinary steel is given by the following formula:

$$I = 50 \times (\text{Øe} - 1)$$

Where:

I = intensity of the welding current

Øe = electrode diameter

Example:

For electrode diameter 4 mm

$$I = 50 \times (4 - 1) = 50 \times 3 = 150A$$

## TIG welding with "Lift"

In the TIG process welding is achieved by melting the two metal pieces to be joined, with the possible addition of material from the outside, using an arc ignited by a tungsten electrode. The "Lift" type ignition used in **DIGITECH vision PULSE** equipments makes it possible to reduce tungsten inclusions on ignition to a minimum. The molten bath and the electrode are protected by an inert gas (for example, Argon). This type of welding is used to weld thin sheet metal or when elevated quality is required.

- 1) Connecting the welding cables (Fig. E):
  - Connect one end of the gas hose to the gas connector on the TIG torch and the other end to the pressure reducer on the inert gas cylinder (Argon or similar).
  - With the machine switched off:
    - Connect the ground cable to the snap-on connector marked + (positive).
    - Connect the relative ground clamp to the workpiece or to the workpiece support in an area free of rust, paint, grease, etc..
    - Connect the TIG torch power cable to the snap-on connector marked - (negative).
- 2) Switch the welding machine on by moving the power supply switch to I (Pos. 3, Fig. A).
- 3) Make the adjustments and do the parameter settings on the control panel (for further information see the DH control panel manual).
- 4) Open the gas cylinder and regulate the flow by adjusting the valve on the TIG torch by hand.

- 5) Ignite the electric arc by contact, using a decisive, quick movement without dragging the tungsten electrode on the piece to be welded ("Lift" type ignition).
- 6) The welder has a SWS "Smart Welding Stop" system for the end of TIG welding. Lifting up the torch without switching off the arc will introduce a slope down and it will switch off automatically.
- 7) When you have finished welding remember to shut the valve on the gas cylinder.

Table 5 shows the currents to use with the respective electrodes for TIG DC welding. This input is not absolute but is for your guidance only; read the electrode manufacturers' instructions for a specific choice. The diameter of the electrode to use is directly proportional to the current being used for welding.

**Table 5**

Ø ELECTRODE (mm)	ELECTRODE TYPE Current adjustment field (A)	
	TIG DC	
	Tungsten Ce 1% Grey	Tungsten Rare ground 2% Turquoise
1	10-50	10-50
1,6	50-80	50-80
2,4	80-150	80-150
3,2	150-250	150-250
4	200-400	200-400

## Maintenance

**ATTENTION:** Cut off the power supply to the equipment before effecting any internal inspection.

### DIGITECH vision PoWerTech 4000/5000 Vision Pulse

**IMPORTANT:** For fully electronic welding machines, removing the dust by sucking it into the machine by the fans, is of utmost importance.

In order to achieve correct functioning of the machine, proceed as described:

- Periodic removal of accumulations of dirt and dust inside the equipment using compressed air. Do not point the jet of air directly at the electrical parts as this could damage them.
- Periodical inspection for worn cables or loose connections that could cause overheating.

### TORCH

The torch is subjected to high temperatures and is also stressed by traction and torsion. We recommend not to twist the wire and not to use the torch to pull the welder. As a result of the above the torch will require frequent maintenance such as:

- Cleaning welding splashes from the gas diffuser so that the gas flows freely.
- Substitution of the contact point when the hole is deformed.
- Cleaning of the wire guide liner using trichloroethylene or specific solvents.
- Check of the insulation and connections of the power cable; the connections must be in good electrical and mechanical condition.

### SPARE PARTS

Original spares have been specifically designed for our equipment. The use of spares that are not original may cause variations in the performance and reduce the safety level of the equipment. We are not liable for damage due to use of spare parts that are not original.

## Optional

---

**NOTE:** *The digital control unit of the generator is fitted with a control recognition device which allows it to identify which device is connected and take action accordingly.*

### REMOTE CONTROL ANALOGIC RC

This command (that must be plugged into the relevant connector on the front panel of the Wire Feeder drawing unit):

- Completely replaces the ENCODER - A knob on the Wire Feeder feeder's front panel.
- Partially (depending on the welding process selected) replaces the ENCODER - V knob on the Wire Feeder feeder's front panel (for further information see the DH control panel manual).

### AIR AND/OR WATER COOLED UP/DOWN TORCH

This command (that must be plugged into the relevant connector on the front panel of the Wire Feeder drawing unit) works as an alternative to:

- The ENCODER - A knob on the Wire Feeder feeder's front panel. In "synergic" MIG MAG and "manual" MIG MAG welding processes, by pressing the two right (+) and left (-) buttons you can regulate the values for the synergic welding parameters.
- The ENCODER - V knob on the Wire Feeder feeder's front panel. In the JOB welding process, by pressing the two right (+) and left (-) buttons you can scroll the welding points set previously.

## The pointing out of any difficulties and their elimination

---

The supply line is attributed with the cause of the most common difficulties. In the case of breakdown, proceed as follows:

- 1) Check the value of the supply voltage.
- 2) Check that the power cable is perfectly connected to the plug and the supply switch.
- 3) Check that the power fuses are not burned out or loose.
- 4) Check whether the following are defective:
  - The switch that supplies the machine
  - The plug socket in the wall
  - The generator switch

**NOTE:** *Given the required technical skills necessary for the repair of the generator, in case of breakdown we advise you to contact skilled personnel or our technical service department.*

## Replacing the digital interface PCB

---

Proceed as follows:

- Unscrew the 4 screws fastening the front rack panel.
- Remove both the adjustment knobs.
- Extract wiring connectors from the digital interface PCB.
- Unscrew the nuts and washers on the support.
- Remove the digital interface PCB by lifting it out of its supports.
- Proceed vice versa to assemble the new digital interface PCB.

# Wiring diagram

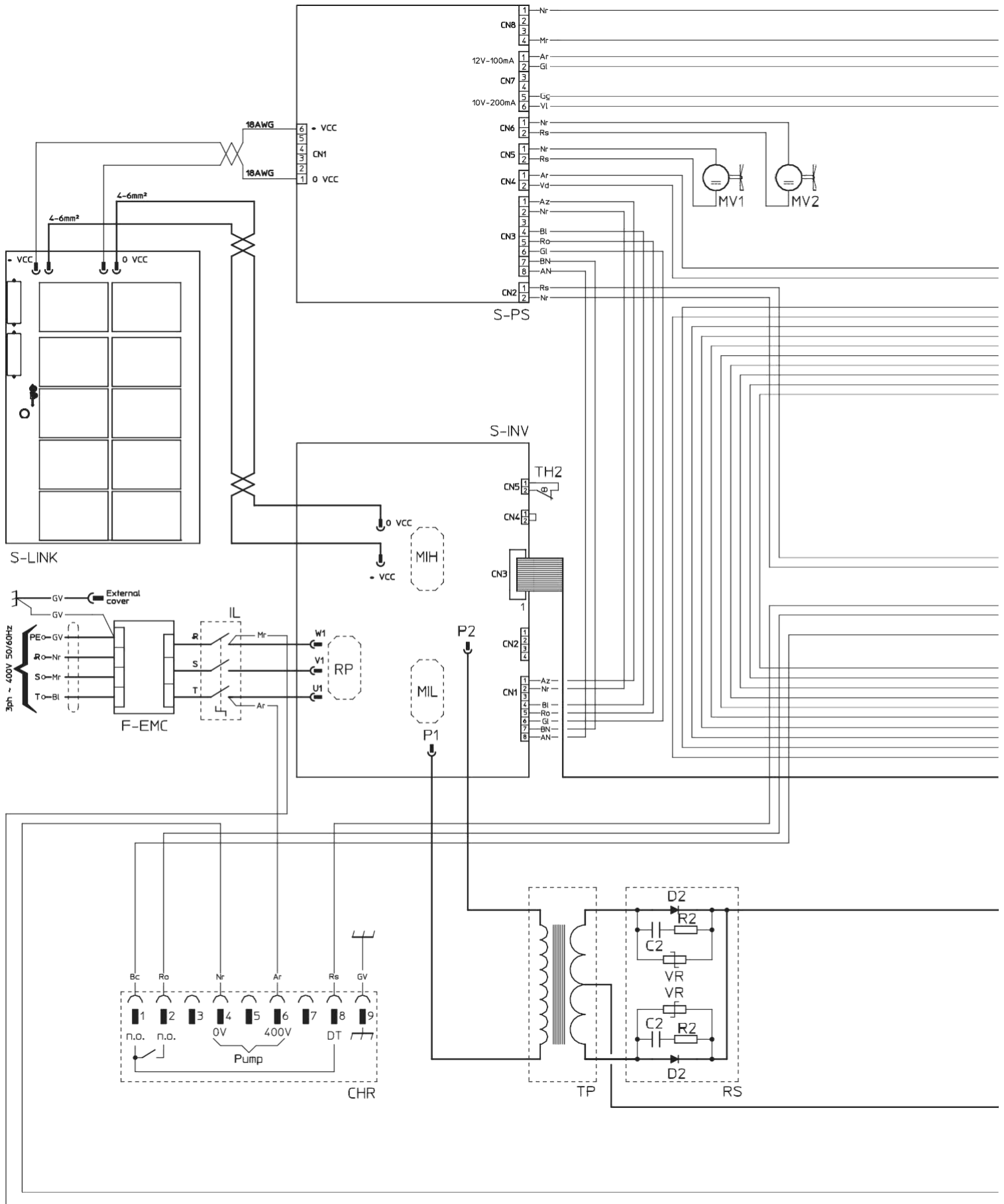





## Key to the electrical diagram

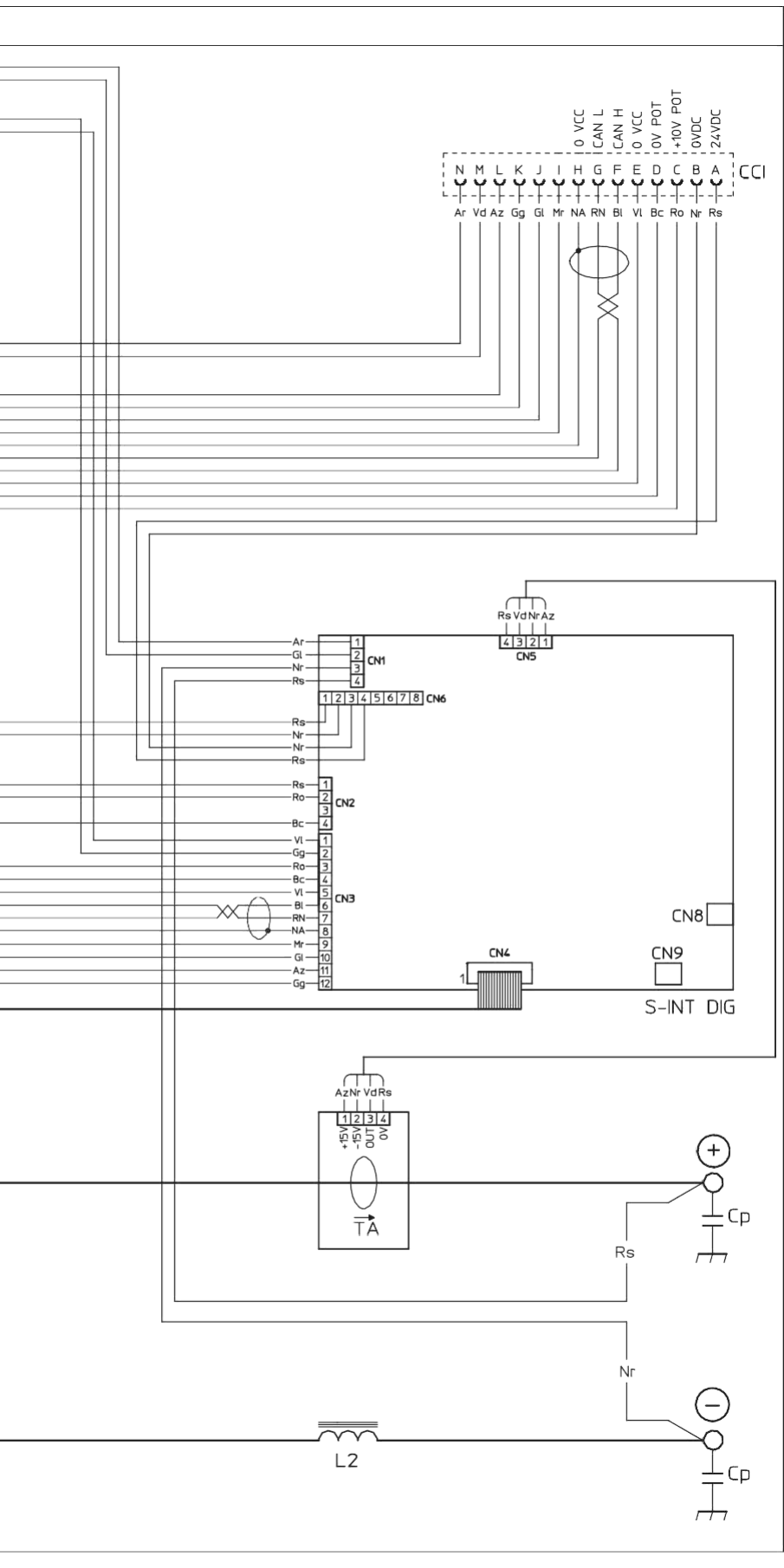

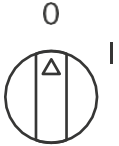

•1 C2	•2 CCI	•3 CHR	•4 Cp	•5 D2
•6 F-EMC	•7 IL	•8 L2	•9 MIH	•10 MIL
•11 MV1-2	•12 P1	•13 P2	•14 R2	•15 RP
•16 RS	•17 S-INT DIG		•18 S-INV	•19 S-LINK
•20 S-PS	•21 TA	•22 TH2	•23 TP	•24 VR

- 1 SNUBBER capacitor for output diodes
- 2 Interconnection cable connector
- 3 Cooling system power connector
- 4 Quick connection protection capacitor
- 5 Secondary diode
- 6 EMC filter
- 7 Mains switch
- 8 Secondary inductor
- 9 Primary upper IGBT
- 10 Lower primary IGBT
- 11 Fan motor
- 12 Main primary transformer (start)
- 13 Main primary transformer (end)
- 14 Output diode snubber resistor
- 15 Primary rectifier
- 16 Secondary rectifier
- 17 Digital interface PCB
- 18 Inverter PCB
- 19 Capacitors PCB
- 20 Power Source PCB
- 21 Hall effect transformer
- 22 Secondary thermostat
- 23 Main transformer
- 24 Output diodes snubber varistor

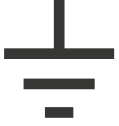

## Meaning of graphic symbols on machine

	Power supply switch
	System for use in environments with increased risk of electroshock
	Product suitable for free circulation in the European Community
	Danger! high voltage
	Grounding

	Positive pole snap-in connector
	Negative pole snap-in connector
	Warning!
	Before using the equipment, you should carefully read the instructions included in this manual
	Special disposal

# PoWerTech Series



# GeKaMac®



## **PoWerTech 4000 5000 Vision Pulse Users Manual**

Please Read and Understand This Manual  
Before Operating The Welding Machine

[www.gedikwelding.com](http://www.gedikwelding.com)



Pos.	4000	5000	Descrizione	Description
1	352389	352389	Pivot	Pivot
2	352461	352461	Visiera rack frontale	Front rack visor
3	439381	439382	Pannello rack, con adesivo "DIGITECH", senza display	Rack panel with "DIGITECH" sticker without display
4	378020	378020	Display	Display
5	438849	438849	Manopola senza indice Ø22mm	Ø22mm Knob without index
6	438888	438888	Manopola senza indice Ø29mm	Ø29mm Knob without index
7	468725	468725	Adesivo logo GEKA Ø30mm	GEKA logo sticker Ø30mm
8	352458	352458	Pannello frontale senza adesivo logo GEKA Ø30mm	Front panel without GEKA logo sticker Ø30mm
9	403617	403617	Attacco rapido	Quick connection
10	420685	420685	Coperchio lato sinistro con adesivo logo GEKA	Left cover with GEKA logo sticker



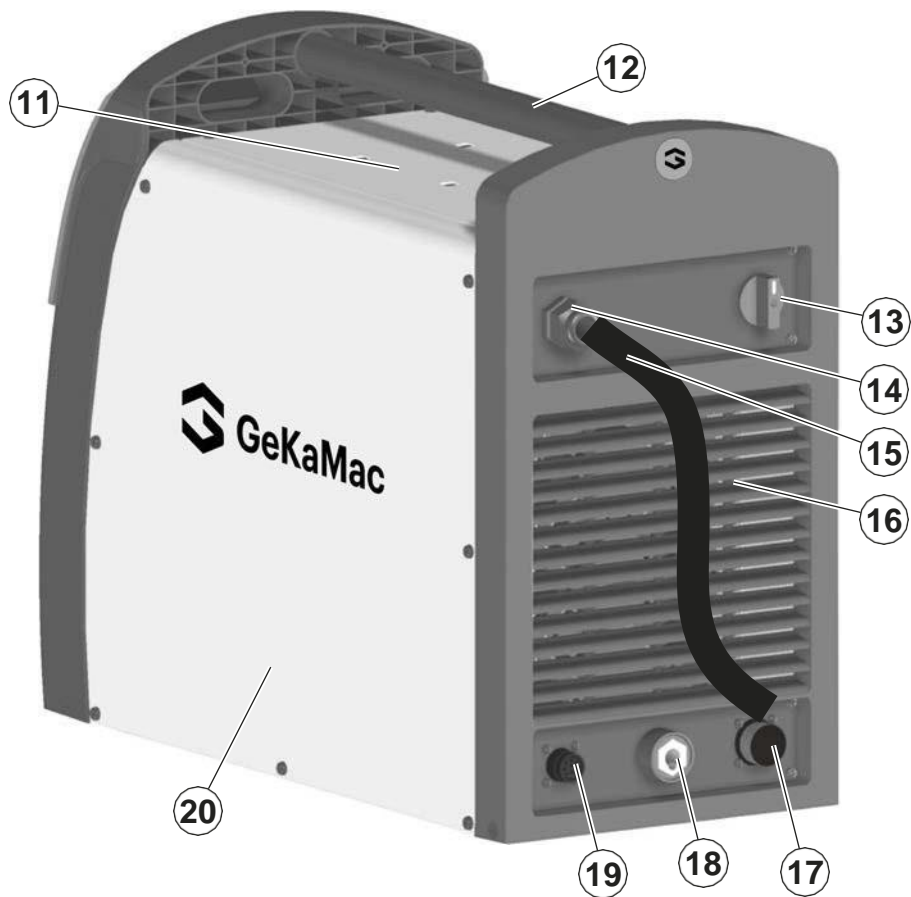

Pos.	4000	5000	Description
11	420577	420577	Top cover
12	438111	438111	Handle
13	438720	438720	Mains switch knob
14	427883	427883	Cable clamp with lock ring
15	235999	235943	Mains cable
16	352459	352459	Rear panel without GEKA logo sticker Ø30mm
17	453145	453145	Interconnection cable connector
18	403617	403617	Quick connection
19	419049	419049	Cooling system power connector
20	420686	420686	Right cover with GEKA logo sticker
21	404931	404931	Base
22	286034	286042	Primary IGBT
23	455508	455508	Primary rectifier
24	240466	240468	Primary inverter assembly
25	377133	377133	Capacitors PCB
26	449578	449578	Upper plate
27	427667	427667	EMC Filter
28	435753	435753	Mains switch
29	486379	486379	Fan motor
30	377105	377105	Snubber secondary PCB
31	481954	481954	Hall effect transformer
32	478786	478786	Secondary thermostat
33	423236	423236	Secondary diode
34	247494	247494	Secondary inductor
35	418887	418887	Quick connection protection capacitor
36	463215	463216	Transformer support
37	481421	481422	Main transformer
38	413499	413499	Auxiliary wiring
39	377113	377113	Power source PCB
40	377149G	377149H	Digital Interface PCB
41	454150	454150	Encoder

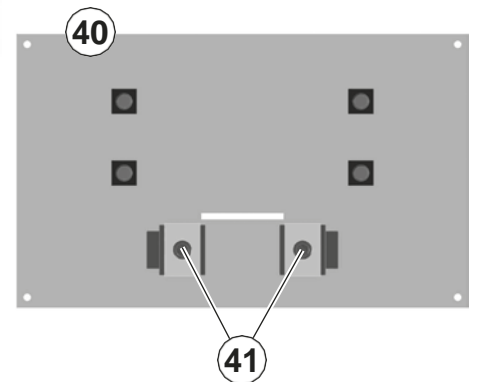
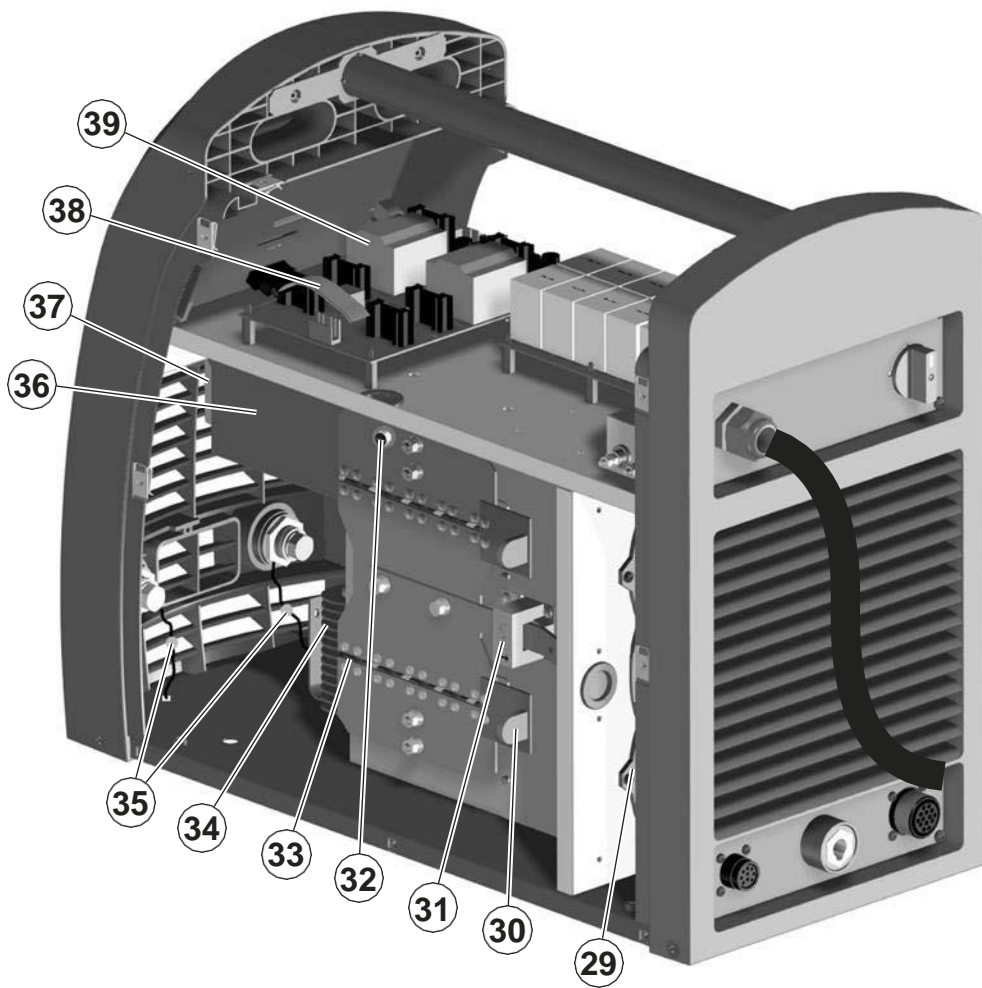
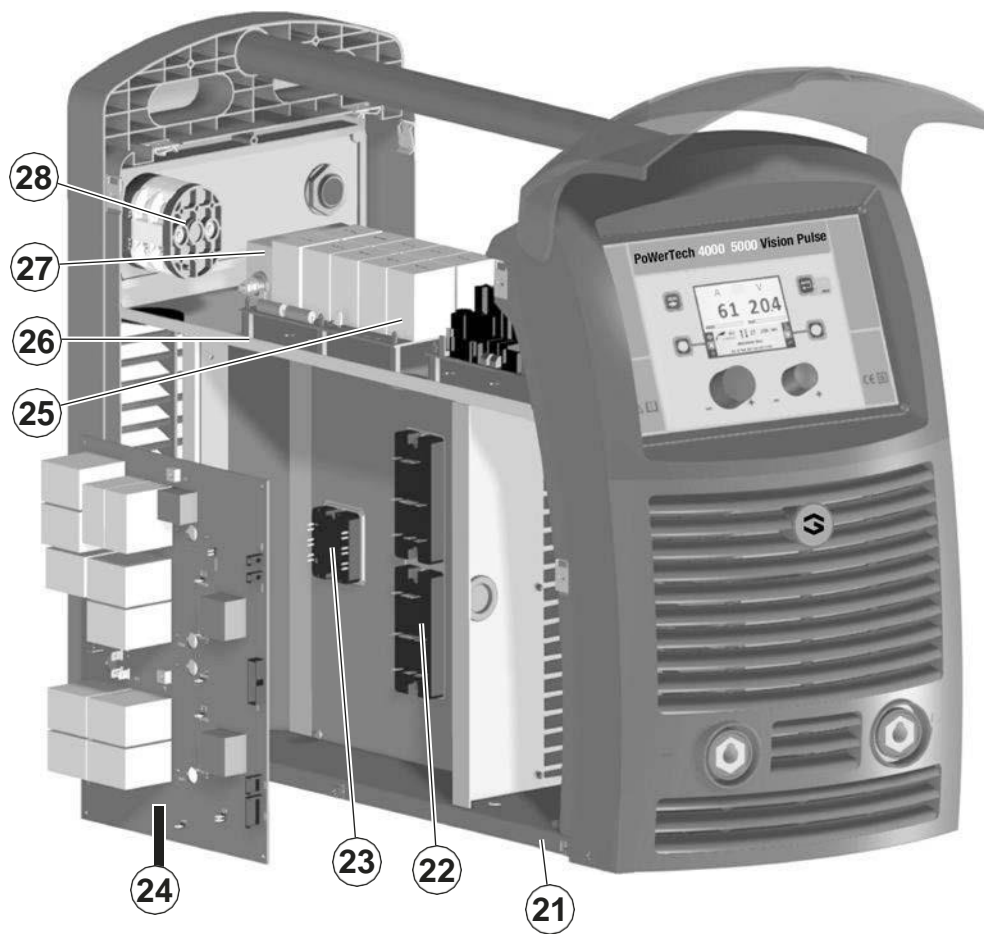

**EN** **Ordering spare parts**

---

To ask for spare parts clearly state:

- 1) The code number of the piece
- 2) The type of device
- 3) The voltage and frequency read on the rating plate
- 4) The serial number of the same

**EXAMPLE**

N. 2 pieces code n. 420577 - for PoWerTech 5000 Vision  
"PULSE - 400V - 50/60 Hz - Serial number  
.....

# PoWerTech Series



# GeKaMac®



## **PoWerTech 4000 5000 Vision Pulse Users Manual**

Please Read and Understand This Manual  
Before Operating The Welding Machine

[www.gedikwelding.com](http://www.gedikwelding.com)



# ENGLISH

<input type="checkbox"/>	Introduction .....	4
<input type="checkbox"/>	General notes .....	4
<input type="checkbox"/>	Welding machine control panel .....	4
<input type="checkbox"/>	Wire feeder control panel .....	4
	WELDING MODE SELECTION Key.....	5
<input type="checkbox"/>	Switching on the welding machine .....	6
<input type="checkbox"/>	Language selection.....	6
<input type="checkbox"/>	Screen saver.....	6
<input type="checkbox"/>	WELDING PROCESS SELECTION Menu (PROCESS) .....	7
<input type="checkbox"/>	MIG-MAG, MIG pulse/dual pulse (Vision.PIPE, Vision.COLD, Vision.POWER, Vision.ULTRASPEED only if activated) .	8
	1 - PROGRAM SELECTION Menu (PROGRAM) .....	8
	2 - WELDING MODE SELECTION Menu (MODE).....	8
	3 - SPECIAL FUNCTIONS Menu (SET UP Fx) .....	9
	4 - PRE-SETTING.....	13
	5 - WELDING .....	14
	6 - HOLD.....	15
	7 - WIRE LOADING .....	16
	8 - DOUBLE FEEDER .....	16
<input type="checkbox"/>	MMA.....	17
	1 - PROGRAM SELECTION Menu (PROGRAM) .....	17
	2 - SPECIAL FUNCTIONS Menu (SET UP Fx) .....	17
	3 - PRE-SETTING.....	19
	4 - WELDING .....	20
	5 - HOLD.....	21
	6 - ACTIVATING THE VRD DEVICE.....	22
<input type="checkbox"/>	TIG LIFT .....	23
	1 - SPECIAL FUNCTIONS Menu (SET UP Fx) .....	23
	2 - PRE-SETTING.....	24
	3 - WELDING .....	25
	4 - HOLD.....	26
<input type="checkbox"/>	JOB/SEQUENCES .....	27
	1 - Creating and saving / editing and overwriting a JOB/SEQUENCES (*) .....	27
	2 - JOB/SEQUENCES SELECTION Menu.....	28
	3 - PRE-SETTING.....	29
	4 - WELDING .....	31
	5 - HOLD.....	32

<input type="checkbox"/>	Error condition .....	34
<input type="checkbox"/>	SETUP Menu .....	35
	JOB EDIT .....	36
	SEQ EDIT .....	37
	PASSWORD .....	39
	BLOCKS .....	40
	CONFIG .....	41
	FACTORY RESET .....	43
	INFO .....	44
	NETWORK .....	46
	ERROR LOG .....	47
<input type="checkbox"/>	ADVANCED SETUP Menu .....	51
	ADVANCED CONFIG .....	52
	ADVANCED MODE .....	53
	EQUIPMENT LAYOUT .....	55
	WELD LOG .....	60

## Introduction

This manual describes the functions of the software operating the following control panels:

- Wire Feeder 40 +                      Wire Feeder 40 +
- Wire Feeder 50 +                      Wire Feeder 50 +

Functioning of the panels listed above is identical (the functions are the same, but the characteristics differ depending on the type of machine they are fitted on (e.g.: current regulation field).

## General notes

- Any adjustments/changes made on the welder control panel are also displayed automatically on the drag-and-drop control panel and vice versa, the images on the displays of both weld system components could however differ one from the other, as the displays are consistent with adjustments/changes but also independent as far as visualization is concerned.
- The adjustments / changes made are immediately available to the operator, unless indicated otherwise in the manual.

## Welding machine control panel

The panel on the generator has four keys, two encoders, and a colour display. The figure below shows the panel. The figure below shows the image of the panel.

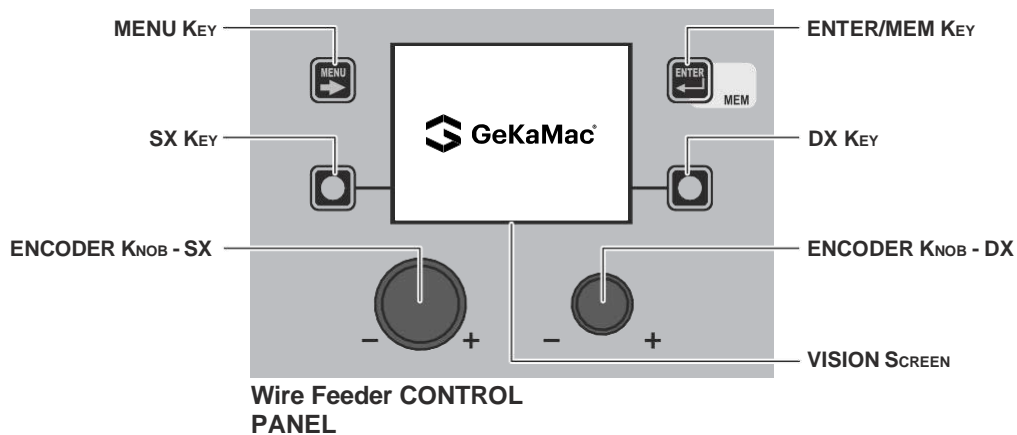

## Wire feeder control panel

The wire feeder panel has 2 keys, 2 encoders and 7 LEDs in the upper section and 4 keys and 5 LEDs in the lower section. The figure below shows the panel. The figure below shows the image of the panel.

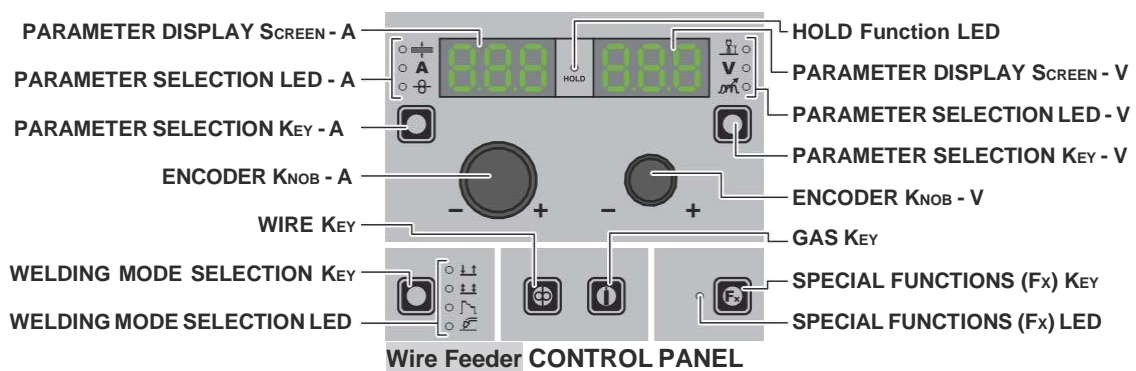

## WELDING MODE SELECTION Key

Each time this is pushed the following welding modes can be selected (only for pulsed and double pulsed MIG, synergic and manual welding processes) on the feeder (on the welding machine the welding mode is selected using a specific menu - see the appropriate paragraphs) according to a specific sequence:

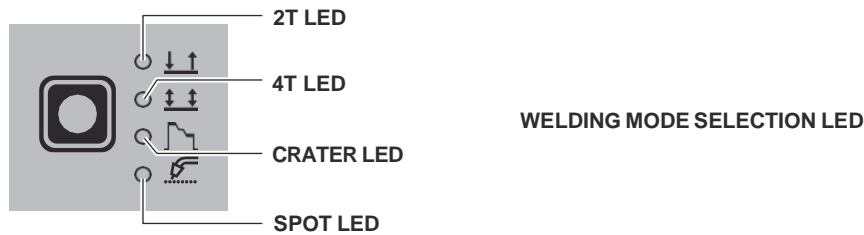

<b>TWO STROKE (2T)</b>	2T LED ( ) switched on
Pressing the TORCH TRIGGER starts the welding cycle, which will stop when it is released.	
<b>FOUR STROKE (4T)</b>	4T LED ( ) switched on
1) Pressing and releasing the TORCH TRIGGER will start the welding cycle. 2) Pressing and releasing the TORCH TRIGGER will stop the welding cycle.	
<b>CRATER 2T</b>	2T LED ( ) switched on - CRATER LED ( ) switched on
1) When the TORCH TRIGGER is pushed the arc ignites and the parameters assume the values for the "initial crater" for a time set by means of the INITIAL CRATER DURATION (F10) function. After that the parameter values become those for "welding" for a time defined by the INITIAL SLOPE (F11) function. 2) When the TORCH TRIGGER is released the parameters take on the "final crater" values for a time set by means of the FINAL CRATER TIME (F15) function, for a period of time set using the FINAL SLOPE (F12) function.	
<b>CRATER 4T</b>	4T LED ( ) switched on - CRATER LED ( ) switched on
1) When the TORCH TRIGGER is pushed the arc ignites and the parameters assume the values for the "initial crater". 2) When the TORCH TRIGGER is released the parameters take on the "welding" values for a time set using the INITIAL SLOPE (F11) function. 3) When the TORCH TRIGGER is pushed again the parameters take on the "final crater" values for a time defined using the FINAL SLOPE (F12) function. 4) Releasing the TORCH TRIGGER will end the welding cycle.	
<b>SPOT WELDING</b>	2T LED ( ) switched on - SPOT LED ( ) switched on
This is used so that on pressing the TORCH TRIGGER spot welding is done for a time period set beforehand (in seconds), after which the arc switches off automatically.	
<b>STITCH WELDING</b>	2T LED ( ) switched on - SPOT LED ( ) flashing
To begin stitch welding: 1) Press the TORCH TRIGGER to start the welding current and wire feed. At this point the welding machine automatically carries out a succession of welded portions followed by a pause, according to the times entered previously. This procedure stops automatically only when the TORCH TRIGGER is released. 2) When the TORCH TRIGGER is pushed again the torch begins a new interval welding cycle.	
<b>CYCLE</b>	4T LED ( ) switched on - CRATER LED ( ) flashing
<b>■ STANDARD</b> 1) When the TORCH TRIGGER is pushed the arc ignites and the parameters assume the values for the "initial crater". 2) When the TORCH TRIGGER is released the parameters take on the "welding" values for a time set using the INITIAL SLOPE (F11) function. 3) When the TORCH TRIGGER is pushed and released within <b>1</b> second, the parameters activated are those set for the "cycle" functions. The operation can be repeated by switching between the "cycle" level and the "welding" level an infinite number of times. 4) When the TORCH TRIGGER is pushed and held down for a period of time of <b>more than 1</b> second, the parameters activated are those with the values for the "final crater" for a period of time defined using the FINAL SLOPE (F12) function. Releasing the TORCH TRIGGER will end the welding cycle.	
<b>■ ADVANCED</b> In ADVANCED operating mode, in addition to the settings described above, the welder is able to set the up "slope" (FIRST SLOPE (F18)) and down "slope" (SECOND SLOPE (F21)) for the "cycle" level.	



## Switching on the welding machine

When the unit is switched on the welding machine's VISION SCREEN, shows the logo as shown below:



VISION Screen

During this operation, on the Wire Feeder panel:

- All the keys and all the encoders are disabled.

## Language selection

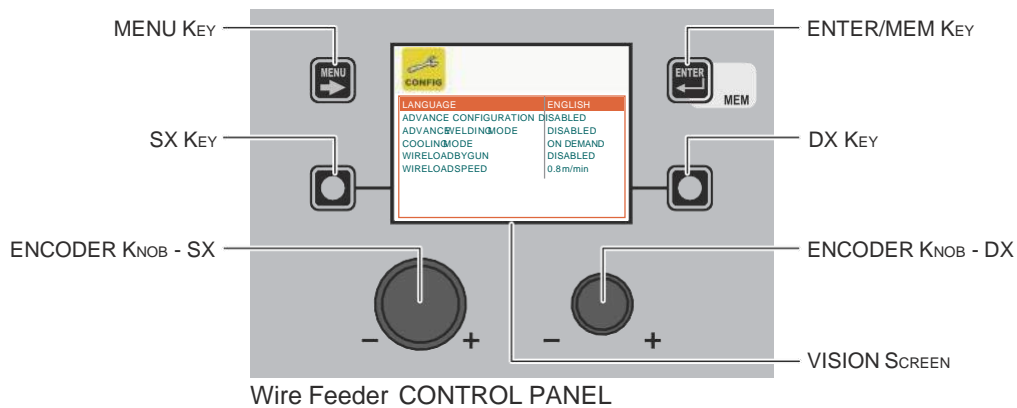

Wire Feeder CONTROL PANEL

On the VISION SCREEN the DEFAULT language set by is ENGLISH.

To select another language, proceed as follows:

- Open the SETUP Menu by holding the SX KEY down for at least 5 consecutive seconds.
- Select the CONFIG Menu by rotating the ENCODER KNOB - SX until the correct icon is reached.
- Push the ENTER/MEM KEY to open the CONFIG Menu.
- Select the LANGUAGE Sub-menu by rotating the ENCODER KNOB - SX.
- Select the language required by rotating the ENCODER KNOB - DX.
- Push the MENU KEY to close the CONFIG Menu.
- Push the MENU KEY to close the SETUP Menu.

Once this has closed, the VISION SCREEN will show the various text / screens in the language selected.

## Screen saver

After a pause or period of inactivity of the welding machine:

- The VISION SCREEN shows the SCREEN SAVER.
- On both the Wire Feeder displays for the wire feeder, "GEKAMAC" appears and scrolls continuously.



VISION Screen



Display Wire Feeder

The SCREEN SAVER mode can be exited in one of the following ways:

- By pushing any key or moving any knob on the welding machine's panel or that of the wire feeder.
- Starting the welding process, in which case the welding is activated in context.
- Moving a remote control.

When the SCREEN SAVER is exited, the welding machine goes back to the working condition prior to activation of the screen saver.



# WELDING PROCESS SELECTION Menu (PROCESS)

## Wire Feeder CONTROL PANEL

To access the *PROCESS SELECTION Menu (PROCESS)* push the **MENU KEY**.

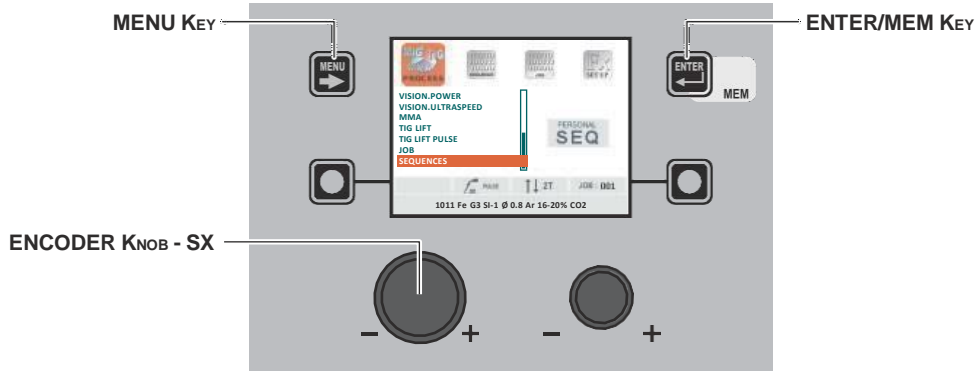
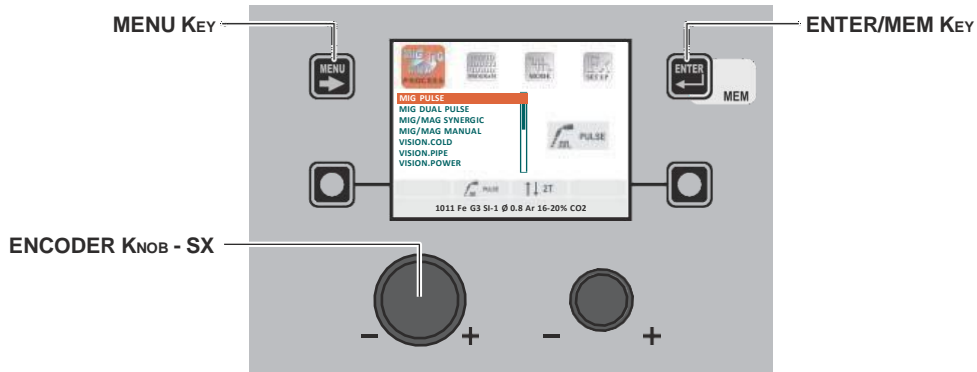

<b>MENU KEY</b>	Provides access to the next menus.
<b>ENCODER KNOB - SX</b>	Select the welding process.
<b>ENTER/MEM KEY</b>	This key is used to access <i>PRE-SETTING</i> for the process selected.

The following processes are available:

- MIG PULSE (only DH)
- MIG DUAL PULSE (only DH)
- MIG-MAG SYNERGIC
- MIG-MAG MANUAL
- VISION.COLD (if activated)
- VISION.PIPE (if activated)
- VISION.POWER (if activated)
- VISION.ULTRASPEED (if activated)
- MMA
- TIG LIFT
- TIG LIFT PULSE
- JOB (if JOBS have been created)
- SEQUENCES (if SEQUENCES have been created)

## Wire Feeder CONTROL PANEL

It is not possible to access the *PROCESS SELECTION Menu (PROCESS)* via the Wire Feeder control panel.

**MIG-MAG, MIG pulse/dual pulse (Vision.PIPE, Vision.COLD, Vision.POWER, Vision.ULTRASPEED only if activated)**

**1 - PROGRAM SELECTION Menu (PROGRAM)**

**Wire Feeder CONTROL PANEL**

To access the *PROGRAM SELECTION Menu (PROGRAM)* push the **MENU KEY**.

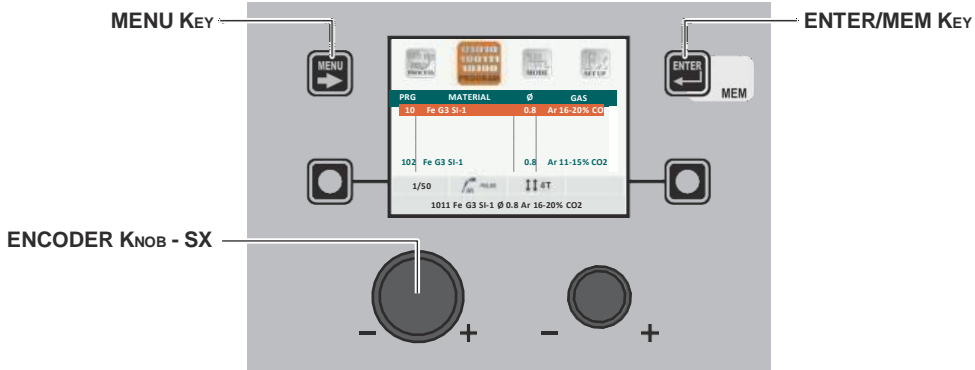

<b>MENU KEY</b>	Used to access subsequent menus if there are any.
<b>ENCODER KNOB - SX</b>	Select the welding program.
<b>ENTER/MEM KEY</b>	Used to access <i>PRE-SETTING</i> of the program selected.

**Wire Feeder CONTROL PANEL**

It is not possible to access the *PROGRAM SELECTION Menu (PROGRAM)* via the Wire Feeder control panel.

**2 - WELDING MODE SELECTION Menu (MODE)**

**Wire Feeder CONTROL PANEL**

To access the *WELDING MODE SELECTION Menu (MODE)* push the **MENU KEY**.

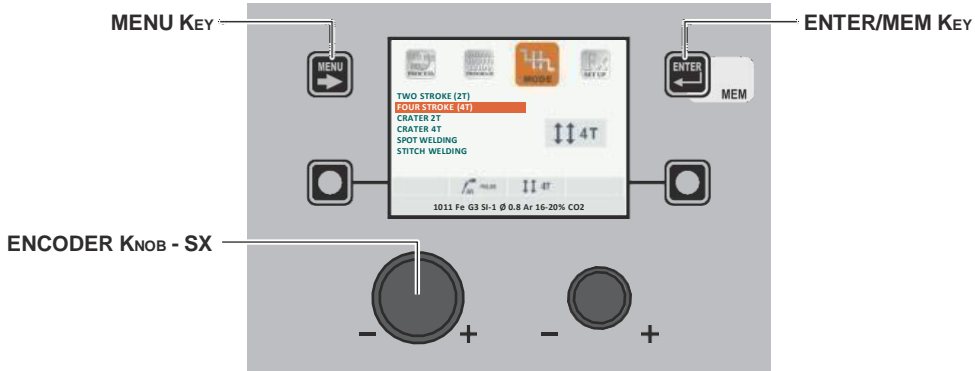

<b>MENU KEY</b>	Used to access subsequent menus if there are any.
<b>ENCODER KNOB - SX</b>	Select the welding mode.
<b>ENTER/MEM KEY</b>	Used to access the <i>PRE-SETTING</i> for the program selected beforehand, in the <i>MODE</i> chosen.

## Wire Feeder CONTROL PANEL

To access the *WELDING MODE SELECTION Menu (MODE)* push the **WELDING MODE SELECTION KEY**.

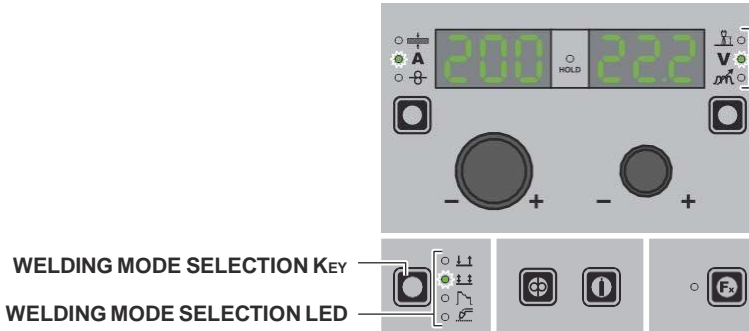

<b>WELDING MODE SELECTION KEY</b>	Scrolls the various welding modes available in succession.
<b>WELDING MODE SELECTION LED</b>	Displays the welding mode selected.

## 3 - SPECIAL FUNCTIONS Menu (SET UP Fx)

### Wire Feeder CONTROL PANEL

To access the *SPECIAL FUNCTIONS Menu (SET UP Fx)* push the **MENU KEY**.

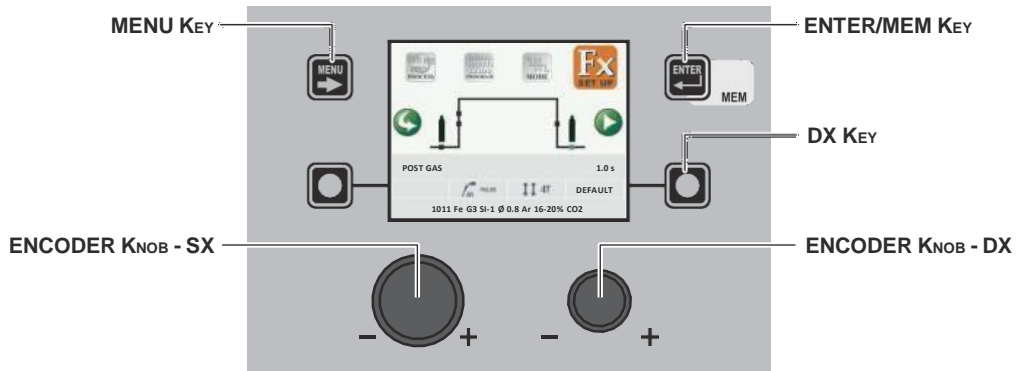

<b>MENU KEY</b>	Used to access subsequent menus if there are any.
<b>ENCODER KNOB - SX</b>	Used to select the various <i>SPECIAL FUNCTIONS (Fx)</i> .
<b>ENTER/MEM KEY</b>	Used to access the <i>PRE-SETTING</i> for the program selected beforehand, in the <i>MODE</i> chosen and with the changes made to the <i>SPECIAL FUNCTIONS (Fx)</i> .
<b>DX KEY</b>	If held down for <b>2</b> seconds it makes it possible to return the value for the <i>SPECIAL FUNCTION (Fx)</i> selected to the <b>DEFAULT</b> value.
<b>ENCODER KNOB - DX</b>	Used to change the selected <i>SPECIAL FUNCTION (Fx)</i> value.

## Wire Feeder CONTROL PANEL

To access the *SPECIAL FUNCTIONS Menu (SET UP Fx)* push the **SPECIAL FUNCTIONS (Fx) KEY**.

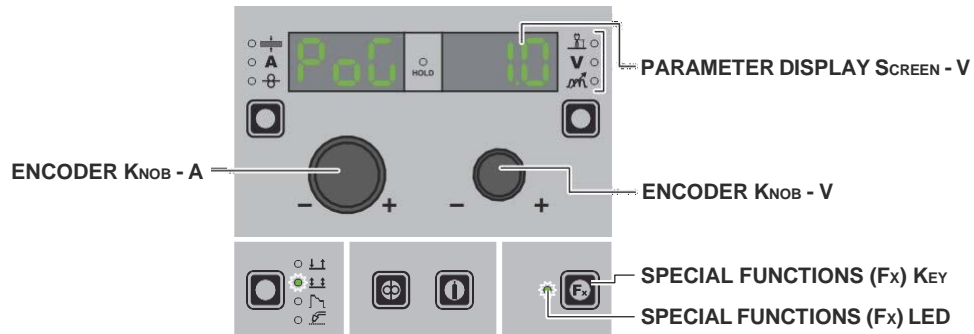

<b>PARAMETER DISPLAY SCREEN - A</b>	Displays the selected <i>SPECIAL FUNCTION (Fx)</i> .
<b>ENCODER KNOB - A</b>	Used to select the various <i>SPECIAL FUNCTIONS (Fx)</i> .
<b>PARAMETER DISPLAY SCREEN - V</b>	Displays the value for the selected <i>SPECIAL FUNCTION (Fx)</i> .
<b>ENCODER KNOB - V</b>	Used to change the selected <i>SPECIAL FUNCTION (Fx)</i> value.
<b>SPECIAL FUNCTIONS (Fx) KEY</b>	Only enables entering and exit afterwards from the <i>SPECIAL FUNCTIONS Menu (SET UP Fx)</i> on the Wire Feeder panel and not on the DH/VS panel.
<b>SPECIAL FUNCTIONS (Fx) LED</b>	The operator must press the <b>SPECIAL FUNCTIONS (SET UP Fx) KEY</b> for it to light up and be included in the <i>SPECIAL FUNCTIONS Menu (SET UP Fx)</i> .

The *SPECIAL FUNCTIONS (Fx)* related to the MIG-MAG synergic, MIG pulsed, MIG double pulsed, Vision.PiPE, Vision.COLD, Vision.POWER, and Vision.ULTRASPEED processes, correspond to the feeder (when fitted) as follows:

Table A

<b>F<sub>x</sub> ADJUSTABLE SPECIAL FUNCTIONS</b>											
Special function	PARAMETER DISPLAY Screen - A	PARAMETER DISPLAY Screen - V		Welding mode							
		Default	Range	TWO STROKE (2T)	FOUR STROKE (4T)	CRATER 2T	CRATER 4T	SPOT WELDING	STITCH WELDING	CYCLE STANDARD	CYCLE ADVANCED
PRE GAS	PrG	0.1s	(0.0 - 2.0)s	•	•	•	•	•	•	•	•
STARTING SPEED	StS	0	-30 - +30	•	•	•	•	•	•	•	•
HOT START	Hot	0	-30 - +30	•	•	•	•	•	•	•	•
STITCH TIME	F05	1.0s	(0.1 - 20.0)s						•		
STITCH PAUSE	F06	1.0s	(0.1 - 20.0)s						•		
SPOT TIME	F07	3.0s	(0.1 - 20.0)s					•			
INITIAL CURRENT	F08	20%	-50% - +100%			•	•			•	•
INITIAL ARC LENGTH	F09	0	-30 - +30			• (*)	• (*)			• (*)	• (*)
INITIAL CRATER TIME	F10	1.0s	(0.0 - 20.0)s			•					
INITIAL SLOPE	F11	1.0s	(0.0 - 20.0)s			•	•			•	•
FINAL SLOPE	F12	1.0s	(0.0 - 20.0)s			•	•			•	•

(continued)

F<sub>x</sub>

## ADJUSTABLE SPECIAL FUNCTIONS

Special function	PARAMETER DISPLAY Screen - A	PARAMETER DISPLAY Screen - V		Welding mode								
		Default	Range	TWO STROKE (2T)	FOUR STROKE (4T)	CRATER 2T	CRATER 4T	SPOT WELDING	STITCH WELDING	CYCLE STANDARD	CYCLE ADVANCED	
FINAL CURRENT	F13	-30%	-100% - +50%			•	•				•	•
FINAL ARC LENGTH	F14	0	-30 - +30			• (*)	• (*)				• (*)	• (*)
FINAL CRATER TIME	F15	0.0s	(0.0 - 20.0)s			•						
BURN BACK	bub	0	-30 - +30	•	•	•	•	•	•	•	•	•
POST GAS	PoG	1.0s	(0.0 - 10.0)s	•	•	•	•	•	•	•	•	•
FIRST SLOPE (I <sub>1</sub> TO I <sub>2</sub> )	F18	0.05s	(0.00 - 2.00)s									•
CYCLE CURRENT	F19	20%	-99% - +100%								•	•
CYCLE ARC LENGTH	F20	0	-30 - +30								•	•
SECOND SLOPE (I <sub>2</sub> TO I <sub>1</sub> )	F21	0.05s	(0.00 - 2.00)s									•
FIRST SLOPE (I <sub>1</sub> TO I <sub>2</sub> )	F22 *	5	(0 - 100)	• (°)	• (°)	• (°)	• (°)	• (°)	• (°)	• (°)	• (°)	• (°)
DUAL PULSE DELTA CURRENT	F23 *	50%	-100% - +200%	•	•	•	•	•	•	•	•	•
DUAL PULSE ARC LENGTH	F24 *	0	-30 - +30	• (°)	• (°)	• (°)	• (°)	• (°)	• (°)	• (°)	• (°)	• (°)
DUAL PULSE BALANCE	F25 *	0%	-40% - +40%	•	•	•	•	•	•	•	•	•
DUAL PULSE FREQUENCY	F26 *	2.7Hz	(0.1 - 5.0)Hz	•	•	•	•	•	•	•	•	•
SECOND SLOPE (I <sub>2</sub> TO I <sub>1</sub> )	F27 *	5	(0 - 100)	• (°)	• (°)	• (°)	• (°)	• (°)	• (°)	• (°)	• (°)	• (°)
SLOPE JOB	F28	0.5s	(0.1 - 20.0) s	•	•	•	•	•	•	•	•	•
DYNAMICS	din **	0	-30 - +30	•	•	•	•	•	•	•	•	•

\* Only for the MIG double pulsed process.

\*\* Only for the Vision.ULTRASPEED process.

**WARNING:**

- The STANDARD or ADVANCED welding CYCLE mode can only be activated by opening the ADVANCED SETUP Menu - ADVANCED MODE - CYCLE (for further explanations, see the relevant paragraph).
- (\*) This SPECIAL FUNCTION is only to be found if the ADVANCED CRATER function has been activated by accessing the ADVANCED SETUP Menu - ADVANCED MODE - CRATER - ADVANCED (for further explanations, see the relevant paragraph).
- (°) These SPECIAL FUNCTIONS can only be activated for all the welding machine's welding modes but going to the ADVANCED SETTINGS Menu - ADVANCED MODE - DOUBLE PULSED - ADVANCED (for further explanations, see the relevant paragraph).
- It is possible to access editing of the SPECIAL FUNCTIONS (F<sub>x</sub>) during welding.
- Some of the values edited will be used immediately by the operator, while others will be active from when the next welding task begins.
- The HOLD function is not active within the SPECIAL FUNCTIONS Menu (SET UP F<sub>x</sub>).

The *SPECIAL FUNCTIONS (Fx)* for the MIG-MAG manual process correspond to the feeder (when fitted) as follows:

Table B

<b>F<sub>x</sub> ADJUSTABLE SPECIAL FUNCTIONS</b>											
Special function	PARAMETER DISPLAY Screen - A	PARAMETER DISPLAY Screen - V		Welding mode							
		Default	Range	TWO STROKE (2T)	FOUR STROKE (4T)	CRATER 2T	CRATER 4T	SPOT WELDING	STITCH WELDING	CYCLE STANDARD	CYCLE ADVANCED
PRE GAS	PrG	0.1s	(0.0 - 2.0)s	•	•	•	•	•	•	•	•
STARTING SPEED	StS	0	-30 - +30	•	•	•	•	•	•	•	•
HOT START	Hot	0	-30 - +30	•	•	•	•	•	•	•	•
STITCH TIME	F05	1.0s	(0.1 - 20.0)s						•		
STITCH PAUSE	F06	1.0s	(0.1 - 20.0)s						•		
SPOT TIME	F07	3.0s	(0.1 - 20.0)s					•			
INITIAL WIRE SPEED	F08	5.0m/min	(0.6-MAX)m/min			•	•			•	•
INITIAL VOLTAGE	F09	25.0V	(10 - MAX)V			•	•			•	•
INITIAL CRATER TIME	F10	1.0s	(0.0 - 20.0)s			•					
INITIAL SLOPE	F11	1.0s	(0.0 - 20.0)s			•	•			•	•
FINAL SLOPE	F12	1.0s	(0.0 - 20.0)s			•	•			•	•
FINAL WIRE SPEED	F13	5.0m/min	(0.6-MAX)m/min			•	•			•	•
FINAL VOLTAGE	F14	25.0V	(10 - MAX)V			•	•			•	•
FINAL CRATER TIME	F15	0.0s	(0.0 - 5.0)s			•					
BURN BACK	bub	0	-30 - +30	•	•	•	•	•	•	•	•
POST GAS	PoG	1.0s	(0.0 - 10.0)s	•	•	•	•	•	•	•	•
FIRST SLOPE (I <sub>1</sub> TO I <sub>2</sub> )	F18	0.05s	(0.00 - 2.00)s								•
CYCLE WIRE SPEED	F19	5.0m/min	(0.6-MAX)m/min							•	•
CYCLE VOLTAGE	F20	25.0V	(10 - MAX)V							•	•
SECOND SLOPE (I <sub>2</sub> TO I <sub>1</sub> )	F21	0.05s	(0.00 - 2.00)s								•
SLOPE JOB	F28	0.5s	(0.1 - 20.0) s	•	•	•	•	•	•	•	•

**WARNING:**

- The STANDARD or ADVANCED welding CYCLE mode can only be activated by opening the *ADVANCED SETUP Menu - ADVANCED MODE - CYCLE* (for further explanations, see the relevant paragraph).
- It is possible to access editing of the *SPECIAL FUNCTIONS (Fx)* during welding.
- Some of the values edited will be used immediately by the operator, while others will be active from when the next welding task begins.
- The *HOLD* function is not active within the *SPECIAL FUNCTIONS Menu (SET UP Fx)*.

## 4 - PRE-SETTING

### Wire Feeder CONTROL PANEL

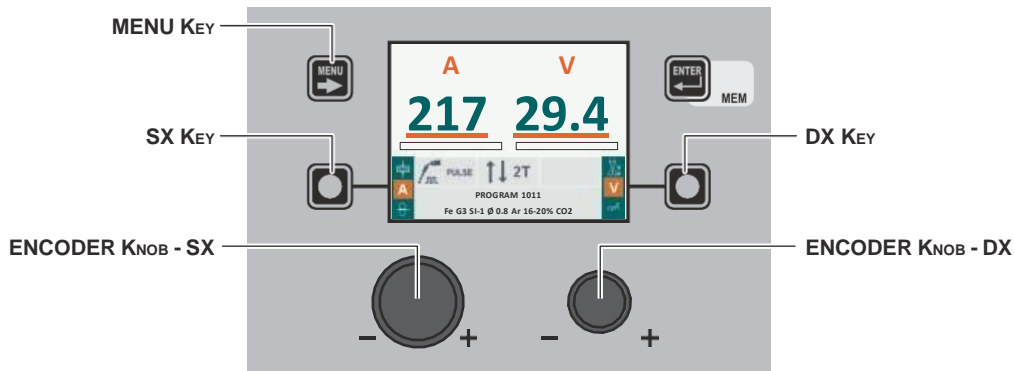

MENU KEY	Used to access the <i>PROCESS SELECTION Menu (PROCESS)</i> and subsequent menus, as applicable.
SX KEY	Scrolls in succession <i>THICKNESS OF WELDED ITEM</i> ( $\frac{1}{4}$ ) - <i>WELDING CURRENT (A)</i> - <i>WIRE SPEED</i> ( $\frac{1}{8}$ ) only on the <b>VISION SCREEN</b> (this operation is activated when the key is released).
ENCODER KNOB - SX	Adjusts the parameter selected using the <b>SX KEY</b> .
DX KEY	Scrolls in succession <i>ARC LENGTH ADJUSTMENT</i> ( $\frac{1}{2}$ ) - <i>WELDING VOLTAGE (V)</i> - <i>ELECTRONIC INDUCTANCE</i> ( $\frac{1}{4}$ ) only on the <b>VISION SCREEN</b> (this operation is activated when the key is released).
ENCODER KNOB - DX	Adjusts the parameter selected using the <b>DX KEY</b> .

### Wire Feeder CONTROL PANEL

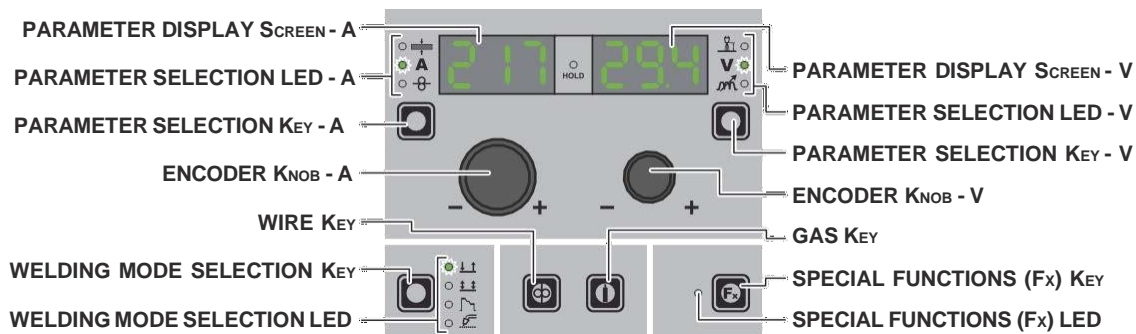

PARAMETER DISPLAY SCREEN - A	Shows the value for the parameter indicated by the <b>PARAMETER SELECTION LED - A</b> .
PARAMETER SELECTION LED - A	The LED unit shows the welding parameter selected using the <b>PARAMETER SELECTION KEY - A</b> .
PARAMETER SELECTION KEY - A	Scrolls in succession <i>THICKNESS OF WELDED ITEM</i> ( $\frac{1}{4}$ ) - <i>WELDING CURRENT (A)</i> - <i>WIRE SPEED</i> ( $\frac{1}{8}$ ).
ENCODER KNOB - A	Adjusts the parameter displayed by the <b>PARAMETER DISPLAY SCREEN - A</b> .
WIRE KEY	Activates loading of the wire.
WELDING MODE SELECTION KEY	Scrolls the various welding modes in succession.
WELDING MODE SELECTION LED	The LED unit indicates the welding mode selected according to the <b>VISION SCREEN</b> .
PARAMETER DISPLAY SCREEN - V	Shows the parameter indicated by the <b>PARAMETER SELECTION LED - V</b> .
PARAMETER SELECTION LED - V	The LED unit indicates the welding parameter selected using the <b>PARAMETER SELECTION KEY - V</b> .
PARAMETER SELECTION KEY - V	Scrolls in succession <i>ARC LENGTH ADJUSTMENT</i> ( $\frac{1}{2}$ ) - <i>WELDING VOLTAGE (V)</i> - <i>ELECTRONIC INDUCTANCE</i> ( $\frac{1}{4}$ ).

(continued)



ENCODER KNOB - V	Adjusts the parameter displayed by the <b>PARAMETER DISPLAY SCREEN - V</b> .
GAS KEY	Activates the flow of gas.
SPECIAL FUNCTIONS (Fx) KEY	Only enables entering and exit afterwards from the <i>SPECIAL FUNCTIONS Menu (SET UP Fx)</i> on the Wire Feeder panel and not on the DH panel.

## 5 - WELDING

When welding takes place the fields in the displays show the same values as those included for pre-setting **with the difference that now they are those measured.**

Wire Feeder CONTROL PANEL

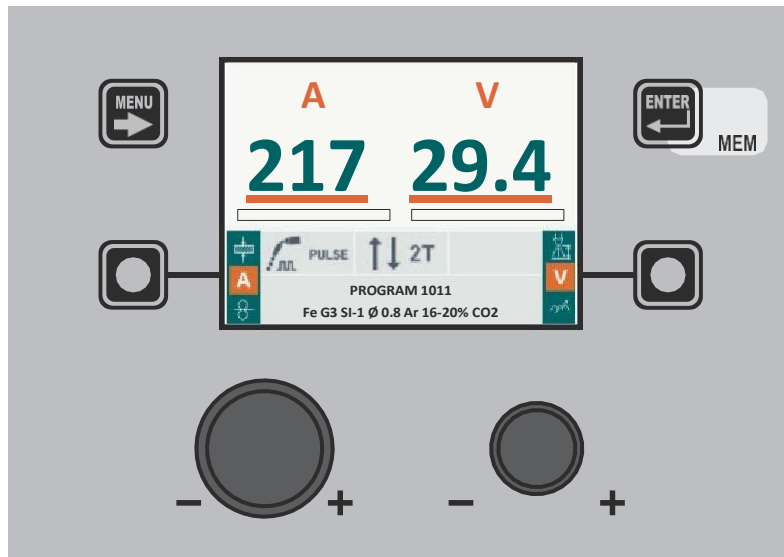

Wire Feeder CONTROL PANEL

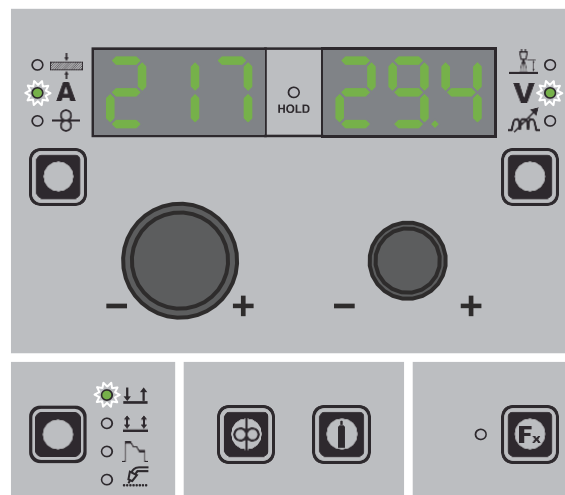

## 6 - HOLD

When welding ends the fields in the display must show the same values that were displayed during welding, with the difference that they are now values defined as *HOLD*. In this phase the **VISION SCREEN** shows the *HOLD* box highlighted, while on the Wire Feeder panel the **HOLD FUNCTION LED** flashes until the end of the *HOLD Function*. If the *HOLD Function* is Interrupted via a panel (e.g. DH), it will also be interrupted automatically on the other (Wire Feeder) and vice-versa.

Wire Feeder CONTROL PANEL

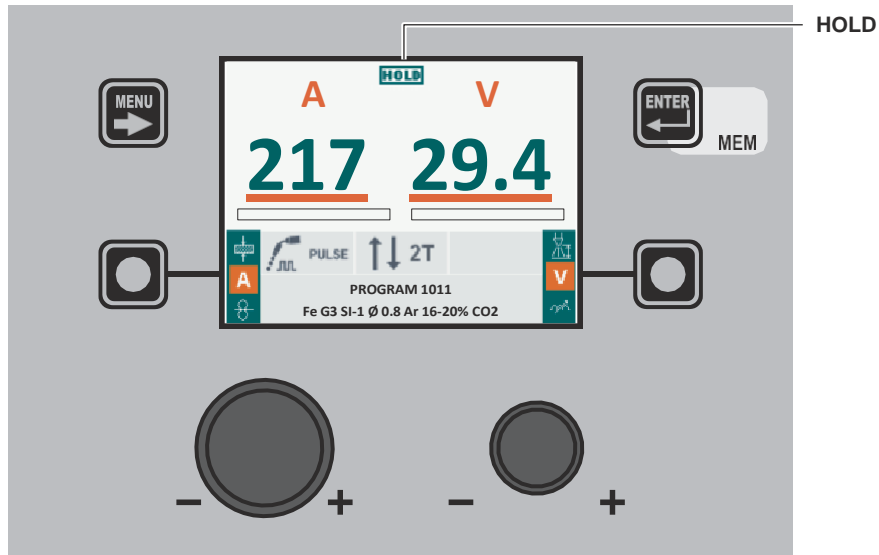

Wire Feeder CONTROL PANEL

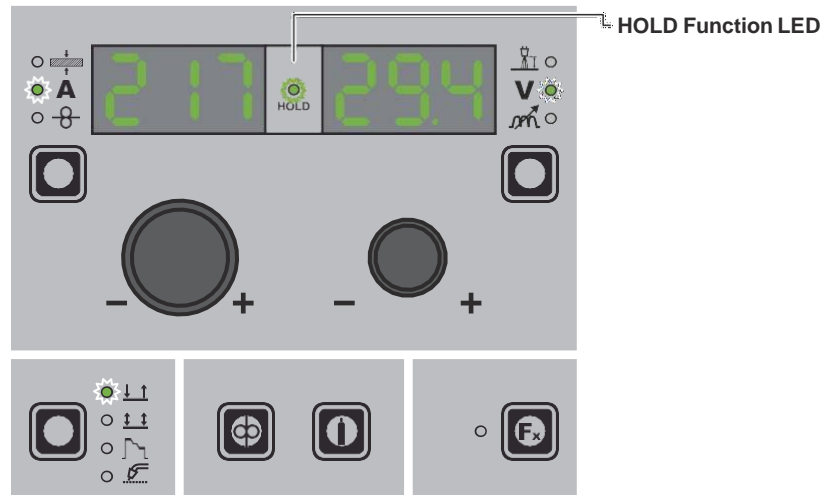

## 7 - WIRE LOADING

The purpose of this menu is to allow the operator to load the welding wire and set the loading speed, **only when welding is not in progress**. If the wire loading function is activated (also see the CONFIG menu), to enable it hold the torch button or the loading button on the feeder down for 4 seconds.

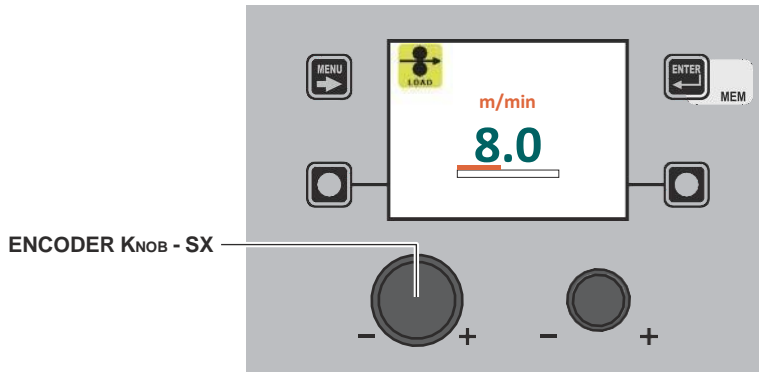

Rotate the **ENCODER KNOB - SX** the wire loading speed can be changed from 1,0 to 22,0 (default 8,0). The other keys and knobs are not active.

When the torch button or the wire loading key on the Wire Feeder feeder are released, the machine goes back to its previous status. **For models not fitted with an Wire Feeder feeder, that is Wire Feeder loading is done by pushing the relevant (wire test / gastest) button, located in the space in which the wire coil is housed.**

**NOTE:** Wire loading cannot be accessed when there are errors on the machine or in the set-up procedure.

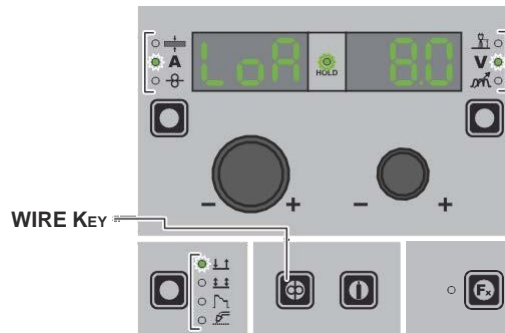

Rotate the **ENCODER KNOB - SX** the wire loading speed can be changed from 1,0 to 22,0 (default 8,0). The other keys and knobs are not active.

## 8 - DOUBLE FEEDER

Two feeders can be connected to the same generator simultaneously. Once everything has been configured correctly, as indicated in the Wire Feederoperator's manual and set as indicated in the equipment layout section, the machine's display shows one of the following two images.

The number **1** or **2** on the display indicates that the feeder in use at that time is number 1 or 2. If no number is displayed, this means that only one feeder has been configured.

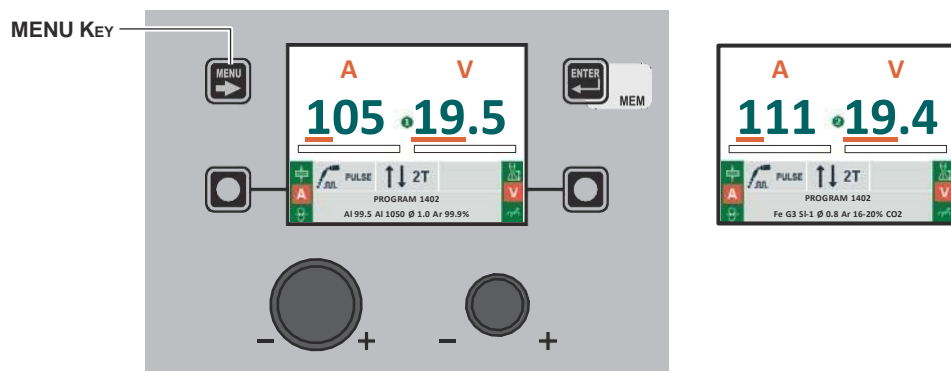

**MENU KEY**

To switch from one feeder to the other, hold down the **MENU KEY**. (\*)

(\*) Switching from one feeder to the other can also be done by pushing the relevant torch button.

Select the MMA welding process by using the **MENU** KEY as explained on page 7.

## 1 - PROGRAM SELECTION Menu (PROGRAM) MMA

### Wire Feeder CONTROL PANEL

To access the *PROGRAM SELECTION Menu (PROGRAM)* push the **MENU** KEY.

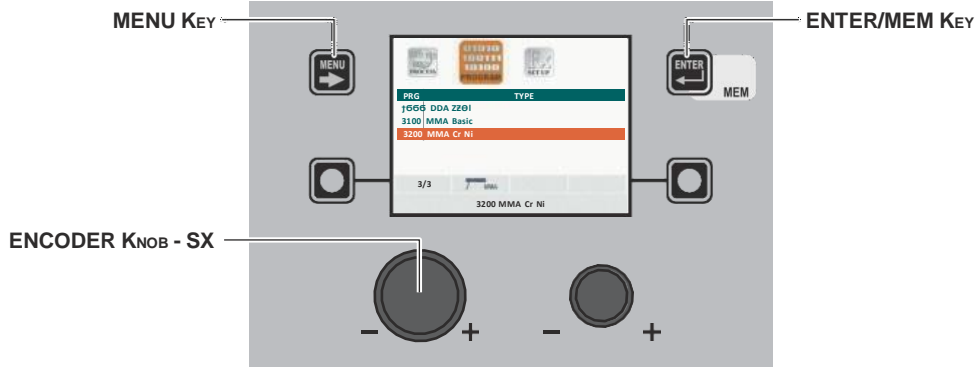

MENU KEY	Used to access subsequent menus if there are any.
ENCODER KNOB - SX	Select the welding program.
ENTER/MEM KEY	Used to access <i>PRE-SETTING</i> of the program selected.

### Wire Feeder CONTROL PANEL

It is not possible to access the *PROGRAM SELECTION Menu (PROGRAM)* via the Wire Feeder control panel.

## 2 - SPECIAL FUNCTIONS Menu (SET UP Fx) MMA

### Wire Feeder CONTROL PANEL

To access the *SPECIAL FUNCTIONS Menu (SET UP Fx)* push the **MENU** KEY.

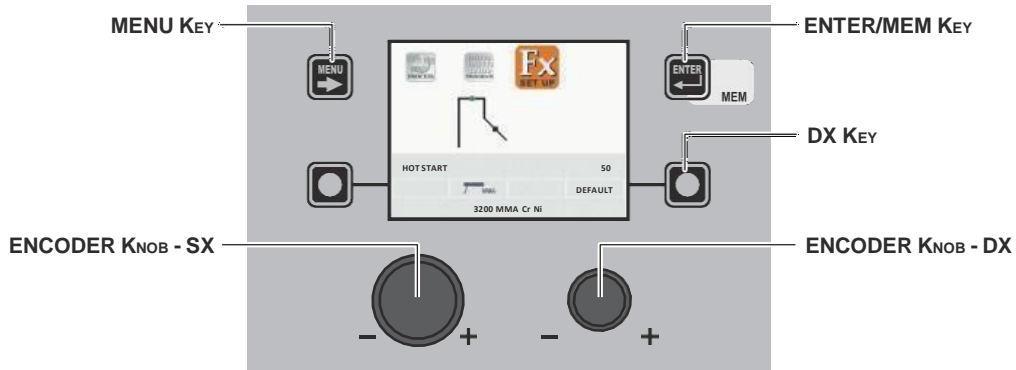

MENU KEY	Used to access subsequent menus if there are any.
ENCODER KNOB - SX	Used to select the various <i>SPECIAL FUNCTIONS (Fx)</i> .
ENTER/MEM KEY	Used to access the <i>PRE-SETTING</i> with the changes made to the <i>SPECIAL FUNCTIONS (Fx)</i> .
DX KEY	If held down for <b>2</b> seconds it makes it possible to return the value for the <i>SPECIAL FUNCTION (Fx)</i> selected to the <i>DEFAULT</i> value.
ENCODER KNOB - DX	Used to change the selected <i>SPECIAL FUNCTION (Fx)</i> value.

## Wire Feeder CONTROL PANEL

To access the *SPECIAL FUNCTIONS Menu (SET UP Fx)* push the **SPECIAL FUNCTIONS (Fx) KEY**.

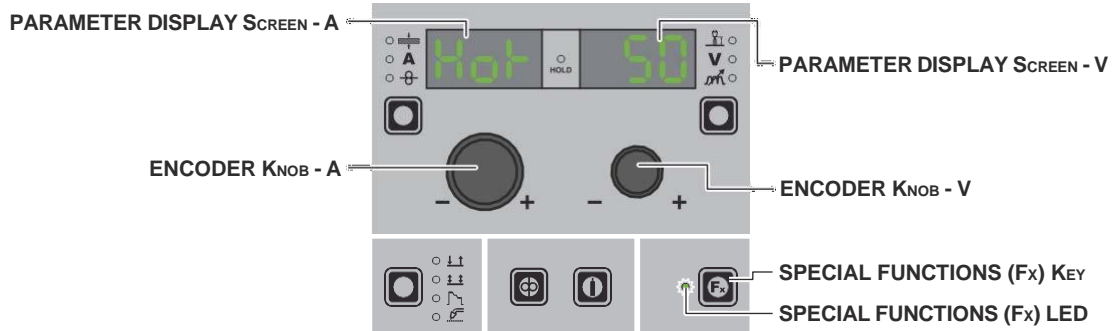

<b>PARAMETER DISPLAY SCREEN - A</b>	Displays the selected <i>SPECIAL FUNCTION (Fx)</i> .
<b>ENCODER KNOB - A</b>	Used to select the various <i>SPECIAL FUNCTIONS (Fx)</i> .
<b>PARAMETER DISPLAY SCREEN - V</b>	Displays the value for the selected <i>SPECIAL FUNCTION (Fx)</i> .
<b>ENCODER KNOB - V</b>	Used to change the selected <i>SPECIAL FUNCTION (Fx)</i> value.
<b>SPECIAL FUNCTIONS (Fx) KEY</b>	Only enables entering and exit afterwards from the <i>SPECIAL FUNCTIONS Menu (SET UP Fx)</i> on the Wire Feeder panel and not on the DH/VS panel.
<b>SPECIAL FUNCTIONS (Fx) LED</b>	The operator must press the <b>SPECIAL FUNCTIONS (SET UP Fx) KEY</b> for it to light up and be included in the <i>SPECIAL FUNCTIONS Menu (SET UP Fx)</i> .

The *SPECIAL FUNCTIONS (Fx)* related to the MMA process correspond as follows to those on the wire feeder:

<b>F<sub>x</sub> ADJUSTABLE SPECIAL FUNCTIONS</b>			
Special function	PARAMETER DISPLAY Screen - A	PARAMETER DISPLAY Screen - V	
		Default	Range
HOT START	Hot	50	(0 - 100)
ARC FORCE	ArC	50	(0 - 100)

**WARNING:**

- It is possible to access editing of the *SPECIAL FUNCTIONS (Fx)* during welding.
- Some of the values edited will be used immediately by the operator, while others will be active from when the next welding task begins.
- The *HOLD* function is not active within the *SPECIAL FUNCTIONS Menu (SET UP Fx)*.

Wire Feeder CONTROL PANEL

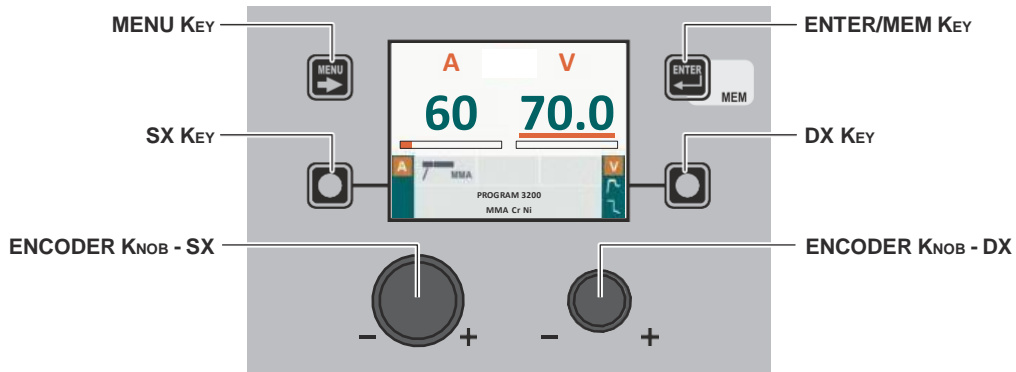

MENU KEY	Used to access the <i>PROCESS SELECTION Menu (PROCESS)</i> and subsequent menus, as applicable.
ENCODER KNOB - SX	Adjust the value of the parameter <i>WELDING CURRENT (A)</i> .
DX KEY	Scrolls in succession <i>WELDING VOLTAGE (V)</i> - <i>HOT START ( )</i> - <i>ARC FORCE ( )</i> only on the <b>VISION SCREEN</b> (the operation is activated when the key is released).
ENCODER KNOB - DX	Adjusts the parameter selected using the <b>DX KEY</b> (only <i>HOT START ( )</i> - <i>ARC FORCE ( )</i> ).

Wire Feeder CONTROL PANEL

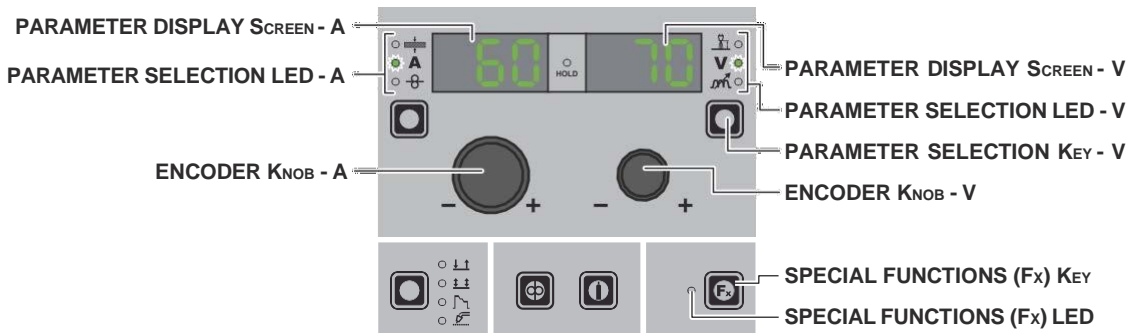

PARAMETER DISPLAY SCREEN - A	Displays the value of the parameter <i>WELDING CURRENT (A)</i> .
PARAMETER SELECTION LED - A	The LED unit shows the <i>WELDING CURRENT (A)</i> switched on.
ENCODER KNOB - A	Adjust the value of the parameter <i>WELDING CURRENT (A)</i> .
PARAMETER DISPLAY SCREEN - V	Shows the parameter indicated by the <b>PARAMETER SELECTION LED - V</b> . The <i>WELDING VOLTAGE</i> shown is the measured voltage.
PARAMETER SELECTION LED - V	The LED unit indicates the welding parameter selected using the <b>PARAMETER SELECTION KEY - V</b> .
PARAMETER SELECTION KEY - V	Scrolls in succession the parameters <i>HOT START ( )</i> - <i>WELDING VOLTAGE (V)</i> - <i>ARC FORCE (mA)</i> .
ENCODER KNOB - V	Adjusts the parameter displayed by the <b>PARAMETER DISPLAY SCREEN - V</b> .
SPECIAL FUNCTIONS (Fx) KEY	Only enables entering and exit afterwards from the <i>SPECIAL FUNCTIONS Menu (SET UP Fx)</i> on the Wire Feeder panel and not on the DH/VS panel.

When welding takes place the fields in the displays show the same values as those included for pre-setting **with the difference that now they are those measured.**

Wire Feeder CONTROL PANEL

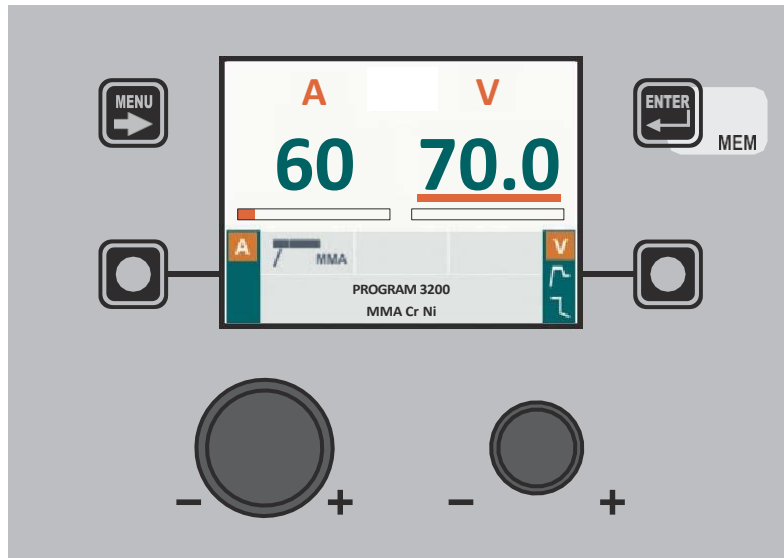

Wire Feeder CONTROL PANEL

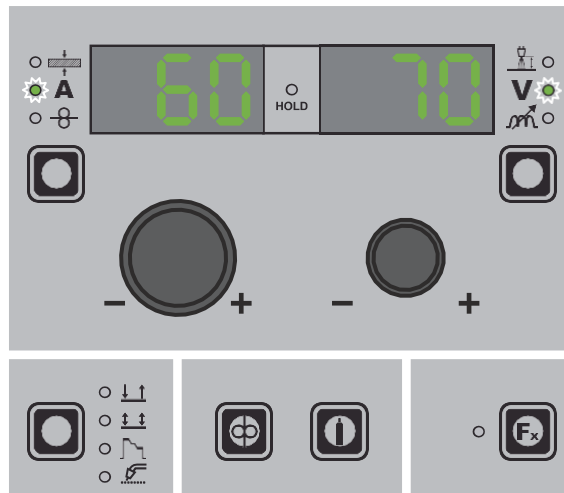

When welding ends the fields in the display must show the same values that were displayed during welding, with the difference that they are now values defined as *HOLD*. In this phase the **VISION SCREEN** shows the *HOLD* box highlighted, while on the Wire Feeder panel the **HOLD FUNCTION LED** flashes until the end of the *HOLD Function*. If the *HOLD Function* is Interrupted via a panel (e.g. DH), it will also be interrupted automatically on the other (Wire Feeder) and vice-versa.

Wire Feeder CONTROL PANEL

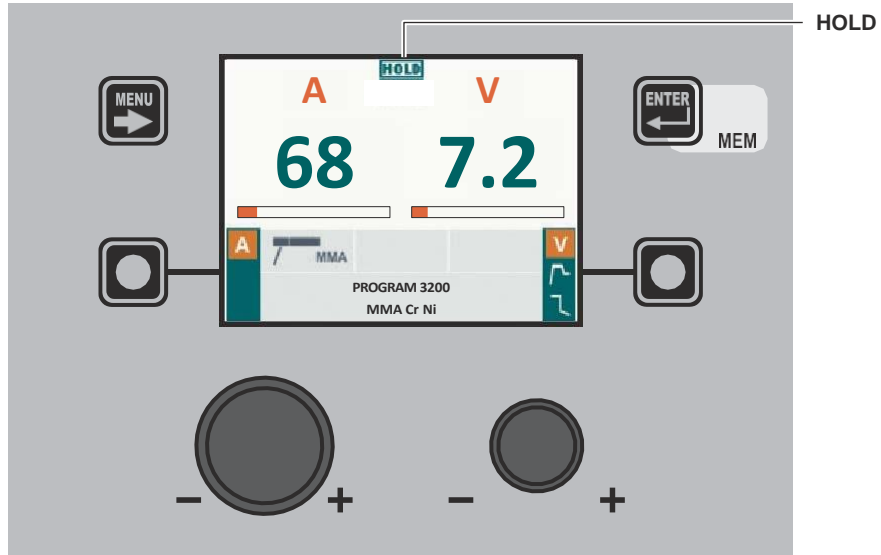

Wire Feeder CONTROL PANEL

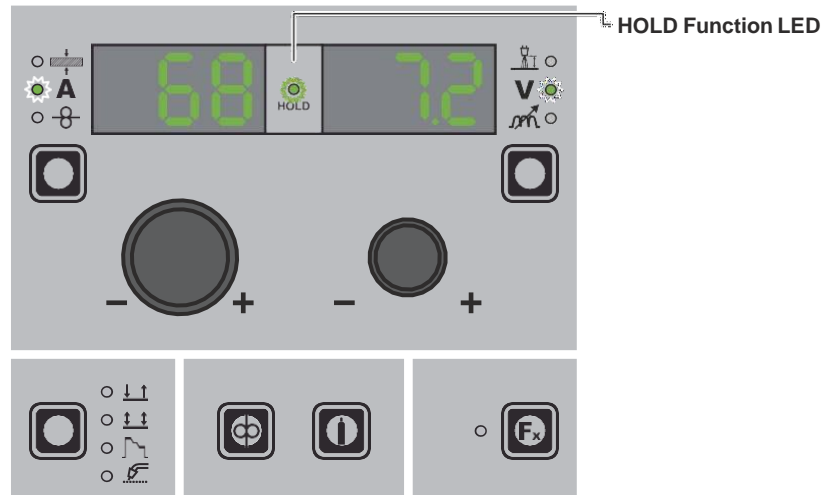



The Voltage Reduction Device (VRD) is a safety device that reduces voltage. It prevents voltages forming on the output terminals that may pose a danger to people. The standard settings and those defined beforehand do not provide for the VRD to be active on the welding machine and so the **VISION SCREEN** does not normally provide any indication.

If the operator wishes to weld in MMA using the VRD device (which must be done with the welding machine switched off), they must:

- 1) Use a suitable screwdriver to unscrew the 4 screws that fix the DH/VS control panel to the welding machine.
- 2) Remove the "VRD" JUMPER on the DIGITAL INTERFACE PCB (see figure).

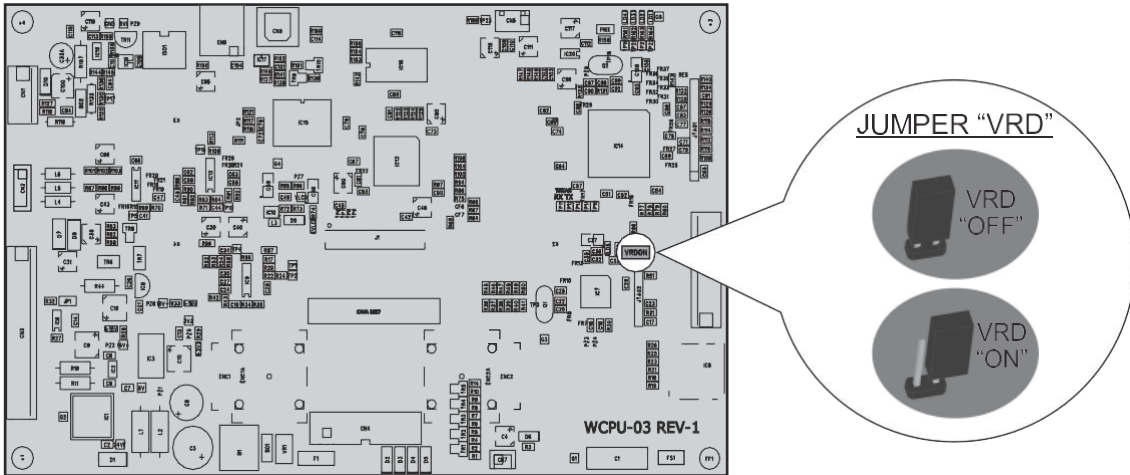

- 3) Use a suitable screwdriver to tighten the 4 screws that fix the DH/VS control panel to the welding machine.
- 4) Start the welding machine by turning the switch on the rear panel to position I.

When it switches on, but with the machine in stand-by, the DH/VS control panel shows that the VRD device is active (indication on the **VISION SCREEN** green colour - see enclosed image: MMA - PRE-SETTING).

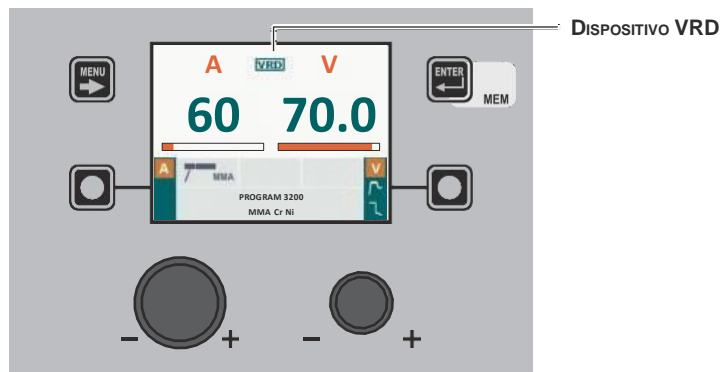

During the welding phase the VRD device is activated (indication on the **VISION SCREEN** red colour (does not indicate malfunctioning of the welding machine) - see enclosed image: MMA - WELDING) and when welding is ended the voltage will be reduced within a maximum time of **0,3** seconds.

Select the TIG LIFT welding process by using the **MENU** KEY as explained on page 7.

**1 - SPECIAL FUNCTIONS Menu (SET UP Fx) TIG LIFT**

**Wire Feeder CONTROL PANEL**

To access the *SPECIAL FUNCTIONS Menu (SET UP Fx)* push the **MENU** KEY.

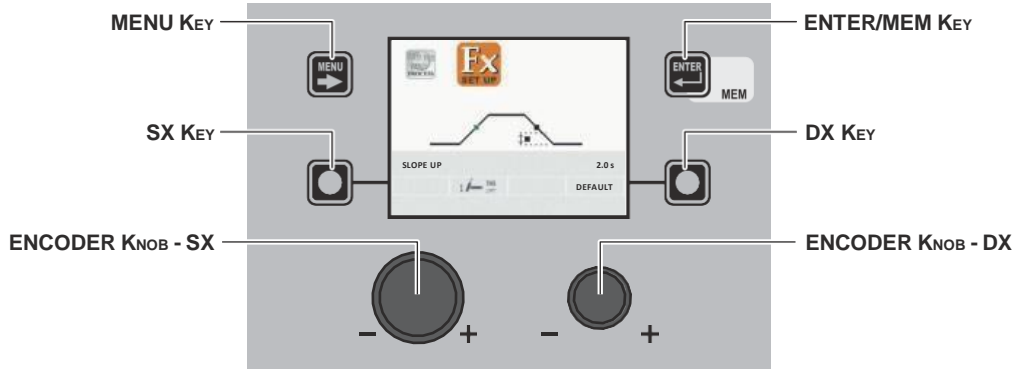

<b>MENU KEY</b>	Used to access subsequent menus if there are any.
<b>ENCODER KNOB - SX</b>	Used to select the various <i>SPECIAL FUNCTIONS (Fx)</i> .
<b>ENTER/MEM KEY</b>	Used to access the <i>PRE-SETTING</i> with the changes made to the <i>SPECIAL FUNCTIONS (Fx)</i> .
<b>DX KEY</b>	If held down for <b>2</b> seconds it makes it possible to return the value for the <i>SPECIAL FUNCTION (Fx)</i> selected to the <b>DEFAULT</b> value.
<b>ENCODER KNOB - DX</b>	Used to change the selected <i>SPECIAL FUNCTION (Fx)</i> value.

**Wire Feeder CONTROL PANEL**

To access the *SPECIAL FUNCTIONS Menu (SET UP Fx)* push the **SPECIAL FUNCTIONS (Fx) KEY**.

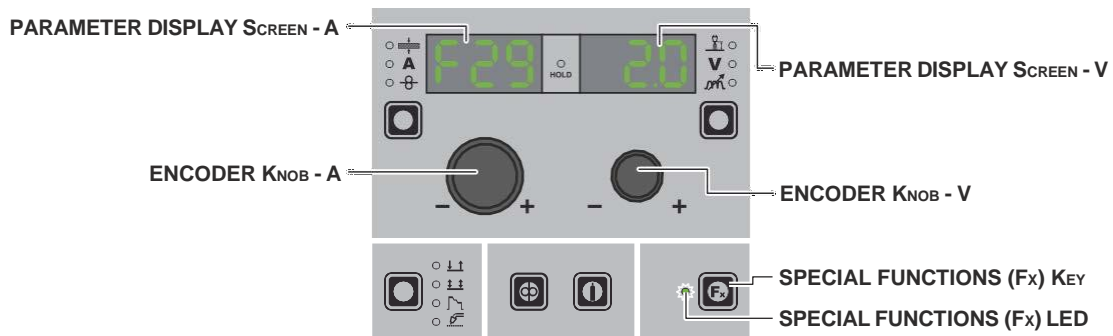

<b>PARAMETER DISPLAY SCREEN - A</b>	Displays the selected <i>SPECIAL FUNCTION (Fx)</i> .
<b>ENCODER KNOB - A</b>	Used to select the various <i>SPECIAL FUNCTIONS (Fx)</i> .
<b>PARAMETER DISPLAY SCREEN - V</b>	Displays the value for the selected <i>SPECIAL FUNCTION (Fx)</i> .
<b>ENCODER KNOB - V</b>	Used to change the selected <i>SPECIAL FUNCTION (Fx)</i> value.
<b>SPECIAL FUNCTIONS (Fx) KEY</b>	Only enables entering and exit afterwards from the <i>SPECIAL FUNCTIONS Menu (SET UP Fx)</i> on the Wire Feeder panel and not on the DH/VS panel.
<b>SPECIAL FUNCTIONS (Fx) LED</b>	The operator must press the <b>SPECIAL FUNCTIONS (SET UP Fx) KEY</b> for it to light up and be included in the <i>SPECIAL FUNCTIONS Menu (SET UP Fx)</i> .

The *SPECIAL FUNCTIONS* ( $F_x$ ) related to the *TIG LIFT* process correspond as follows to those on the wire feeder:

<b>F<sub>x</sub> ADJUSTABLE SPECIAL FUNCTIONS</b>			
Special function	PARAMETER DISPLAY Screen - A	PARAMETER DISPLAY Screen - V	
		Default	Range
UP SLOPE	F29	0.0s	(0.0 - 5.0)s
DOWN SLOPE	F30	2.0s	(0.0 - 8.0)s
TIG PULSE DELTA CURRENT	F23	-50%	(-100 ÷ 1000)%
TIG PULSE BALANCE	F25	0	(-40 ÷ 40)%
TIG PULSE FREQUENCY	F26	100.0Hz	(0.1 ÷ 500.0)Hz
SWS VOLTAGE THRESHOLD	F31	0	-30 - +30

**WARNING:**

- It is possible to access editing of the *SPECIAL FUNCTIONS* ( $F_x$ ) during welding.
- Some of the values edited will be used immediately by the operator, while others will be active from when the next welding task begins.
- The *HOLD* function is not active within the *SPECIAL FUNCTIONS Menu* (*SET UP F<sub>x</sub>*).

**2 - PRE-SETTING** **TIG LIFT**

**Wire Feeder CONTROL PANEL**

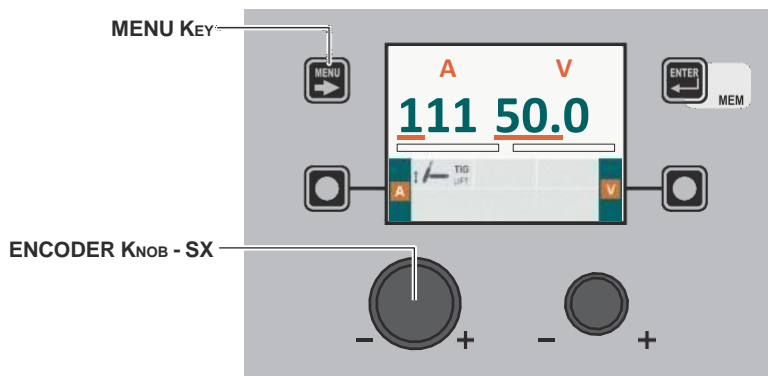

<b>MENU KEY</b>	Used to access the <i>PROCESS SELECTION Menu</i> ( <i>PROCESS</i> ) and subsequent menus, as applicable.
<b>ENCODER KNOB - SX</b>	Adjust the value of the parameter <i>WELDING CURRENT</i> ( <b>A</b> ).

**Wire Feeder CONTROL PANEL**

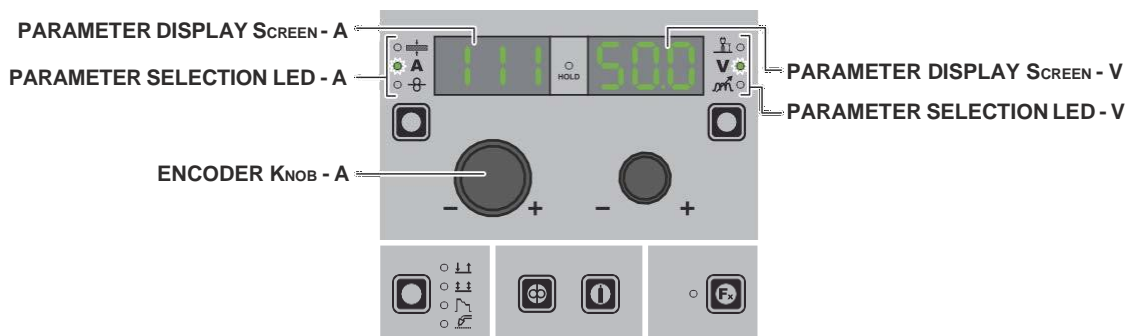

<b>PARAMETER DISPLAY SCREEN - A</b>	Displays the value of the parameter <i>WELDING CURRENT</i> ( <b>A</b> ).
<b>PARAMETER SELECTION LED - A</b>	The LED unit shows the <i>WELDING CURRENT</i> ( <b>A</b> ) switched on.

(continued)

ENCODER KNOB - A	Adjust the value of the parameter <i>WELDING CURRENT (A)</i> .
PARAMETER DISPLAY SCREEN - V	Displays the value of the parameter <i>WELDING VOLTAGE (V)</i> . The <i>WELDING VOLTAGE</i> shown is the measured voltage.
PARAMETER SELECTION LED - V	The LED unit shows the <i>WELDING VOLTAGE (V)</i> switched on.

### 3 - WELDING TIG LIFT

When welding takes place the fields in the displays show the same values as those included for pre-setting **with the difference that now they are those measured.**

Wire Feeder CONTROL PANEL

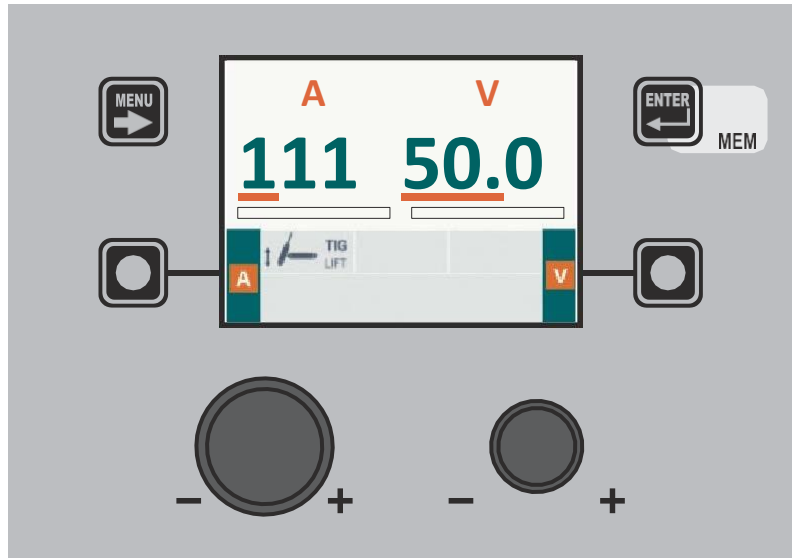

Wire Feeder CONTROL PANEL

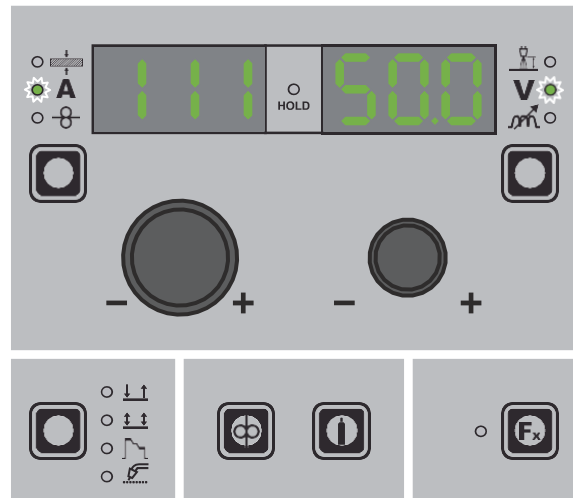

When welding ends the fields in the display must show the same values that were displayed during welding, with the difference that they are now values defined as *HOLD*. In this phase the **VISION SCREEN** shows the *HOLD* box highlighted, while on the Wire Feeder panel the **HOLD FUNCTION LED** flashes until the end of the *HOLD Function*. If the *HOLD Function* is Interrupted via a panel (e.g. DH), it will also be interrupted automatically on the other (Wire Feeder) and vice-versa.

Wire Feeder CONTROL PANEL

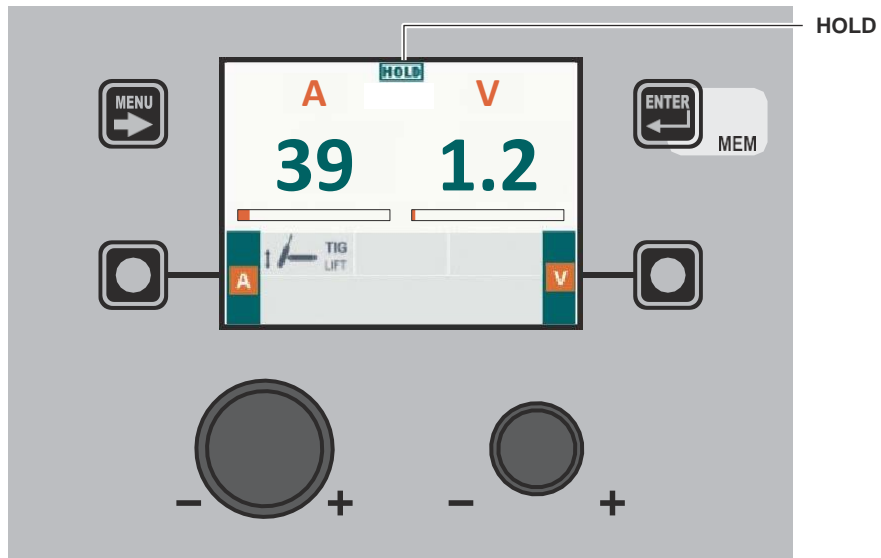

Wire Feeder CONTROL PANEL

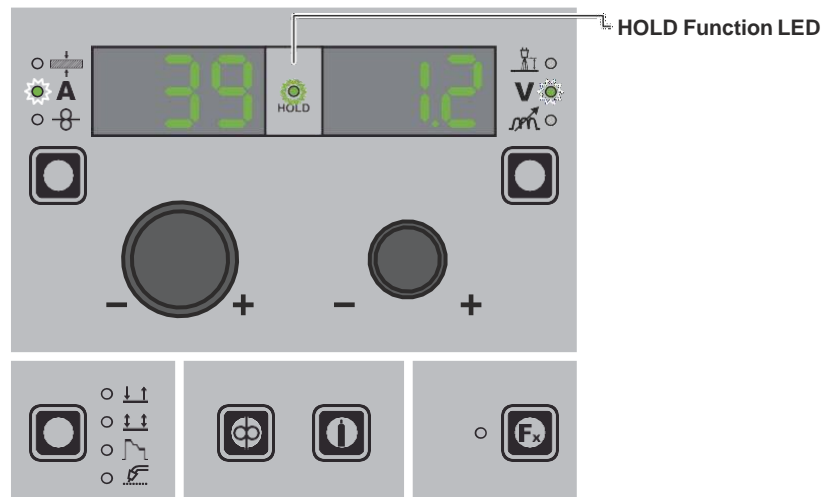

Wire Feeder CONTROL PANEL

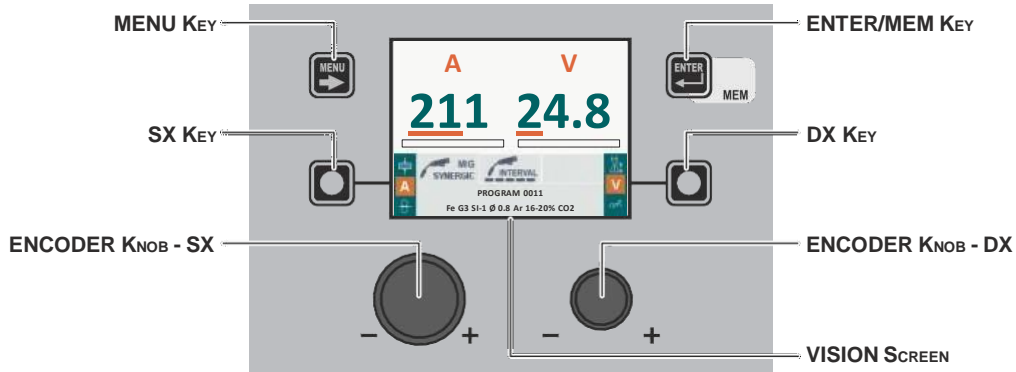

(\*) For the sequences, see the relevant paragraph in the settings menu.

**CREATING AND SAVING A JOB**

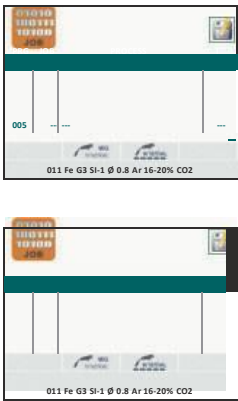

- To create and save a *JOB* (automatic welding point) proceed as follows:
- During any welding process and at any time, once you have acquired the necessary parameters, hold the **ENTER/MEM KEY** down for **3** consecutive seconds.
  - The **VISION SCREEN** automatically goes to the first free position in the *JOB* table.
  - Choose the position in which the *JOB* is to be saved by rotating the **ENCODER KNOB - SX**.
  - Push the **ENTER/MEM KEY** to confirm and finalise saving of the *JOB* created.

**EDITING AND OVERWRITING A JOB**

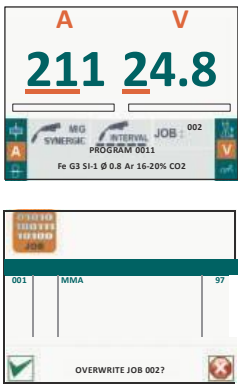

- To edit and/or overwrite a *JOB* proceed as follows:
- During any welding process and at any time push the **MENU KEY** to exit the welding phase.
  - Select the welding process *JOB* by rotating the **ENCODER KNOB - SX**.
  - Push the **MENU KEY** to open the *JOB* table.
  - Select the *JOB* to be edited by rotating the **ENCODER KNOB - SX**.
  - Push the **ENTER/MEM KEY** to view the settings on the **VISION SCREEN** for the *JOB* to be edited.
  - Hold down the **ENTER/MEM KEY** for about **3** consecutive seconds, until the **VISION SCREEN** loads all the parameters / data for the *JOB* onto the screen (making them available to the operator).
  - Acquire the parameters necessary for editing the *JOB*.
  - Hold down the **ENTER/MEM KEY** for **3** consecutive seconds.
  - The **VISION SCREEN** automatically goes to the first free position in the *JOB* table.
  - Choose the free position in which the edited *JOB* is to be saved, or a position already occupied in which the edited *JOB* will be overwritten, by rotating the **ENCODER KNOB - SX**.
  - Push the **ENTER/MEM KEY** to confirm the operation.
  - Push the **SX KEY** to confirm the overwriting operation or the **DX KEY** to cancel it.

Wire Feeder CONTROL PANEL

It is not possible to create, save, edit or overwrite a *JOB/SEQUENCE* using the Wire Feeder control panel.

**WARNING:** All the parameters saved within a JOB/SEQUENCE (including SPECIAL FUNCTIONS (Fx)) can be viewed but not edited!

Wire Feeder CONTROL PANEL

To access the JOB/SEQUENCES SELECTION Menu push the MENU KEY.

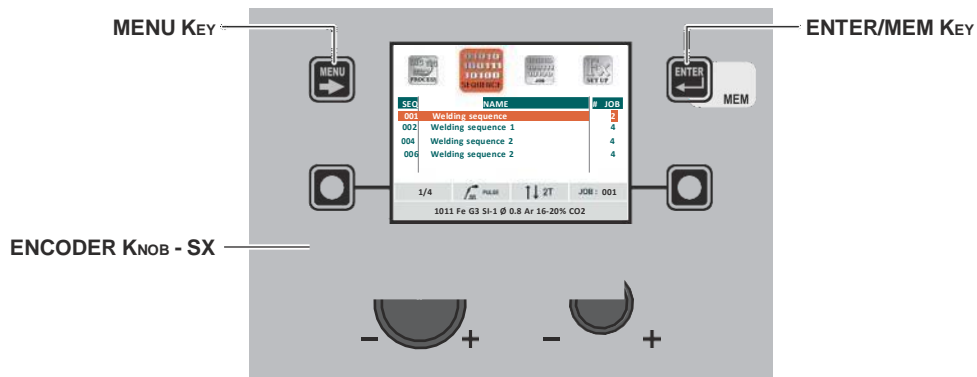
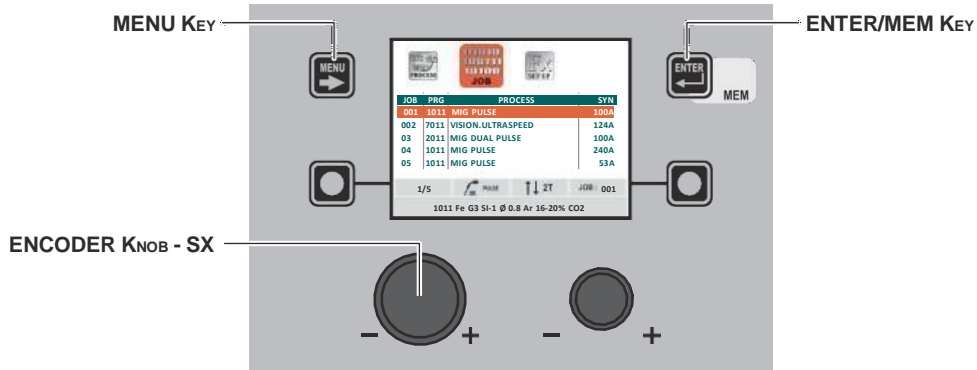

MENU KEY	Used to access subsequent menus.
ENCODER KNOB - SX	Used to scroll and select a JOB/SEQUENCES.
ENTER/MEM KEY	Used to select the JOB/SEQUENCE displayed.

Wire Feeder CONTROL PANEL

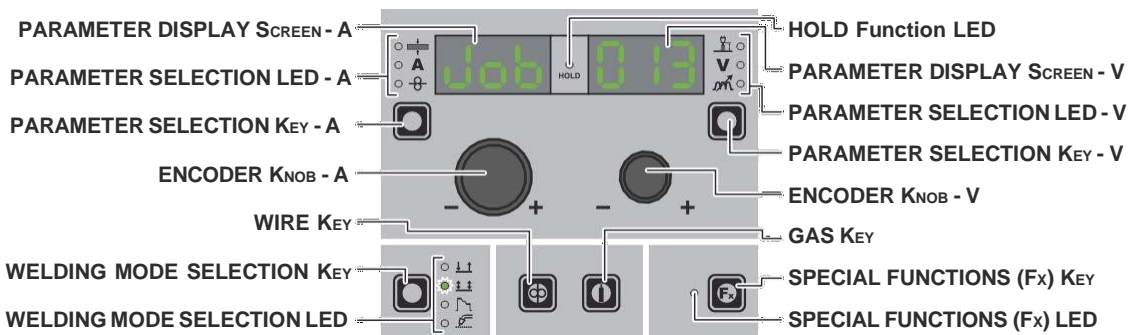

PARAMETER DISPLAY SCREEN - A	Shows the JOB term or value of the parameter indicated by the PARAMETER SELECTION LED - A.
PARAMETER SELECTION LED - A	The LED unit shows the welding parameter selected using the PARAMETER SELECTION KEY - A.
PARAMETER SELECTION KEY - A	Scrolls the active parameters in succession, based on the type of welding process saved in the JOB selected.
WIRE KEY	Activates loading of the wire.

(continued)

WELDING MODE SELECTION LED	The LED unit indicates the welding mode saved in the <i>JOB</i> selected, which is coherent with the <b>VISION SCREEN</b> .
PARAMETER DISPLAY SCREEN - V	Displays the <i>JOB</i> number also selected in the <i>SEQUENCES</i> or the value for the parameter indicated by the <b>PARAMETER SELECTION LED - V</b> .
PARAMETER SELECTION KEY - V	Scrolls the active parameters in succession, based on the type of welding process saved in the <i>JOB</i> selected.
ENCODER KNOB - V	Used to scroll through the <i>JOBS</i> in the <i>SEQUENCES</i> as well.
GAS KEY	Activates the flow of gas.
SPECIAL FUNCTIONS (Fx) KEY	Used to access displaying of the <i>SPECIAL FUNCTIONS (Fx)</i> saved in the <i>JOB</i> selected.

### 3 - PRE-SETTING JOB/SEQUENCES

**WARNING:** All the parameters saved within a *JOB* (including *SPECIAL FUNCTIONS (Fx)*) can be viewed but not edited!

#### Wire Feeder CONTROL PANEL

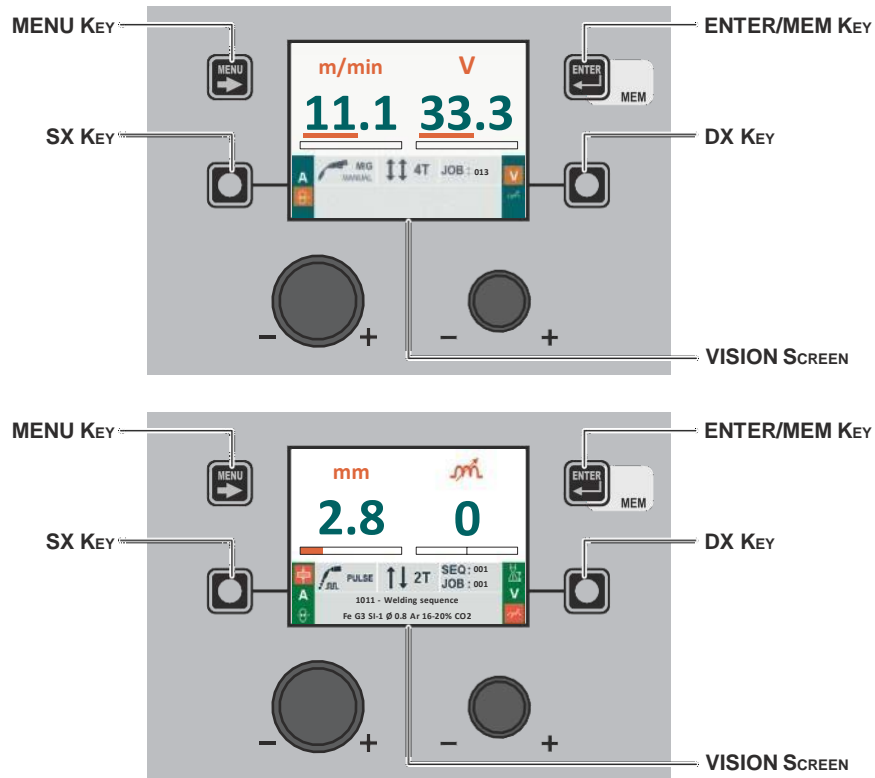

MENU KEY	Used to access the <i>PROCESS SELECTION Menu (PROCESS)</i> and subsequent menus, as applicable.
SX KEY	Scrolls the active parameters in succession, based on the type of welding process saved in the <i>JOB</i> selected.
ENTER/MEM KEY	If held down for a period of about <b>3</b> consecutive seconds, this key allows the <b>VISION SCREEN</b> to load all the parameters for the <i>JOB</i> onto the screen (making them available to the operator).
DX KEY	Scrolls the active parameters in succession, based on the type of welding process saved in the <i>JOB</i> selected.



## Wire Feeder CONTROL PANEL

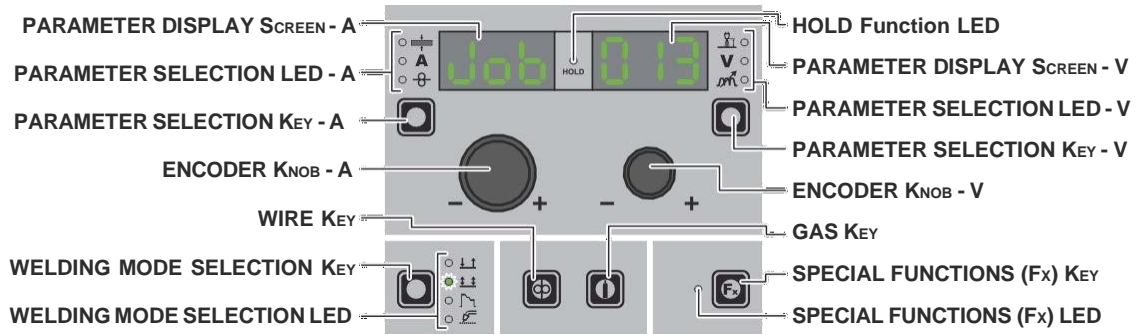

PARAMETER DISPLAY SCREEN - A	Shows the <i>JOB</i> term or value of the parameter indicated by the <b>PARAMETER SELECTION LED - A</b> .
PARAMETER SELECTION LED - A	The LED unit shows the welding parameter selected using the <b>PARAMETER SELECTION KEY - A</b> .
PARAMETER SELECTION KEY - A	Scrolls the active parameters in succession, based on the type of welding process saved in the <i>JOB</i> selected.
WIRE KEY	Activates loading of the wire.
WELDING MODE SELECTION LED	The LED unit indicates the welding mode saved in the <i>JOB</i> selected, which is coherent with the <b>VISION SCREEN</b> .
PARAMETER DISPLAY SCREEN - V	Displays the <i>JOB</i> number also selected in the <i>SEQUENCES</i> or the value for the parameter indicated by the <b>PARAMETER SELECTION LED - V</b> .
PARAMETER SELECTION LED - V	The LED unit indicates the welding parameter selected using the <b>PARAMETER SELECTION KEY - V</b> .
PARAMETER SELECTION KEY - V	Scrolls the active parameters in succession, based on the type of welding process saved in the <i>JOB</i> selected.
ENCODER KNOB - V	Used to scroll through the <i>JOBS</i> in the <i>SEQUENCES</i> as well.
GAS KEY	Activates the flow of gas.
SPECIAL FUNCTIONS (Fx) KEY	Used to access the <i>SPECIAL FUNCTIONS (Fx)</i> saved in the <i>JOB</i> selected.

**WARNING:** All the parameters saved within a JOB (including SPECIAL FUNCTIONS (Fx)) can be viewed but not edited!

Wire Feeder CONTROL PANEL

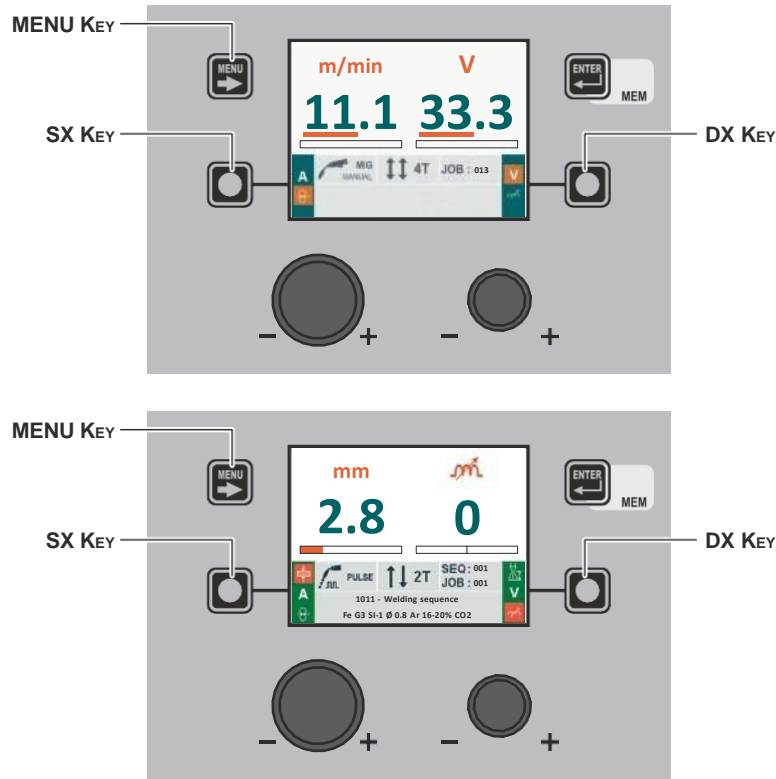

MENU KEY	Used to access the <i>PROCESS SELECTION Menu (PROCESS)</i> and subsequent menus, as applicable.
SX KEY	Scrolls the active parameters in succession, only on the <b>VISION SCREEN</b> , based on the type of welding process saved in the <i>JOB</i> selected. In this case, where possible, the values displayed will be those measured.
DX KEY	Scrolls the active parameters in succession, only on the <b>VISION SCREEN</b> , based on the type of welding process saved in the <i>JOB</i> selected. In this case, where possible, the values displayed will be those measured.

Wire Feeder CONTROL PANEL

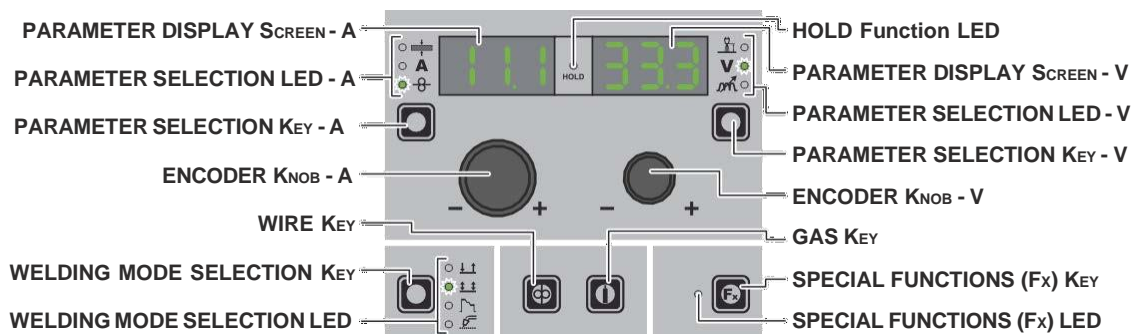

PARAMETER DISPLAY SCREEN - A	Shows the <i>JOB</i> term or value of the parameter indicated by the <b>PARAMETER SELECTION LED - A</b> .
PARAMETER SELECTION LED - A	The LED unit shows the welding parameter selected using the <b>PARAMETER SELECTION KEY - A</b> .
PARAMETER SELECTION KEY - A	Scrolls the active parameters in succession, based on the type of welding process saved in the <i>JOB</i> selected. In this case, where possible, the values displayed will be those measured.

(continued)

WELDING MODE SELECTION LED	The LED unit indicates the welding mode saved in the <i>JOB</i> selected, which is coherent with the <b>VISION SCREEN</b> .
PARAMETER DISPLAY SCREEN - V	Displays the <i>JOB</i> number also selected in the <i>SEQUENCES</i> or the value for the parameter indicated by the <b>PARAMETER SELECTION LED - V</b> .
PARAMETER SELECTION LED - V	The LED unit indicates the welding parameter selected using the <b>PARAMETER SELECTION KEY - V</b> .
PARAMETER SELECTION KEY - V	Used to access displaying of the <i>SPECIAL FUNCTIONS (Fx)</i> saved in the <i>JOB</i> selected.
ENCODER KNOB - V	Used to scroll through the <i>JOBS</i> in the <i>SEQUENCES</i> as well, only if these are coherent. (*)
SPECIAL FUNCTIONS (Fx) KEY	Used to access the <i>SPECIAL FUNCTIONS (Fx)</i> saved in the <i>JOB</i> selected.

(\*) The *JOBS* included in the *SEQUENCES* as well as considered to be coherent when the last three figures (wire type, gas, wire diameter) are equal. **WHEN THIS IS THE CASE JOBS CAN BE CHANGED DURING WELDING WITHOUT INTERRUPTION.**

## 5 - HOLD JOB/SEQUENCES

When welding ends the fields in the display must show the same values that were displayed during welding, with the difference that they are now values defined as *HOLD*. In this phase the **VISION SCREEN** shows the *HOLD* box highlighted, while on the Wire Feeder panel the **HOLD FUNCTION LED** flashes until the end of the *HOLD Function*. If the *HOLD Function* is interrupted via a panel (e.g. DH), it will also be interrupted automatically on the other (Wire Feeder) and vice-versa.

**WARNING:** All the parameters saved within a *JOB* (including *SPECIAL FUNCTIONS (Fx)*) can be viewed but not edited!

### Wire Feeder CONTROL PANEL

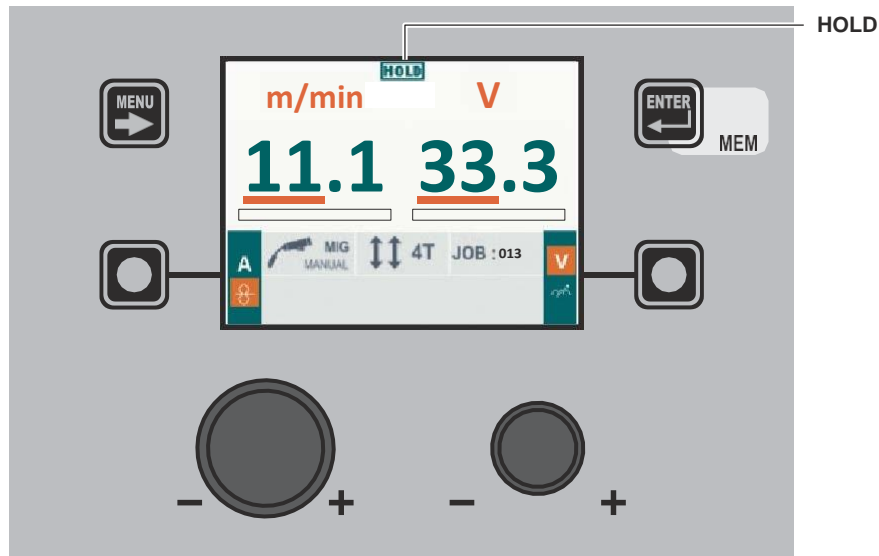

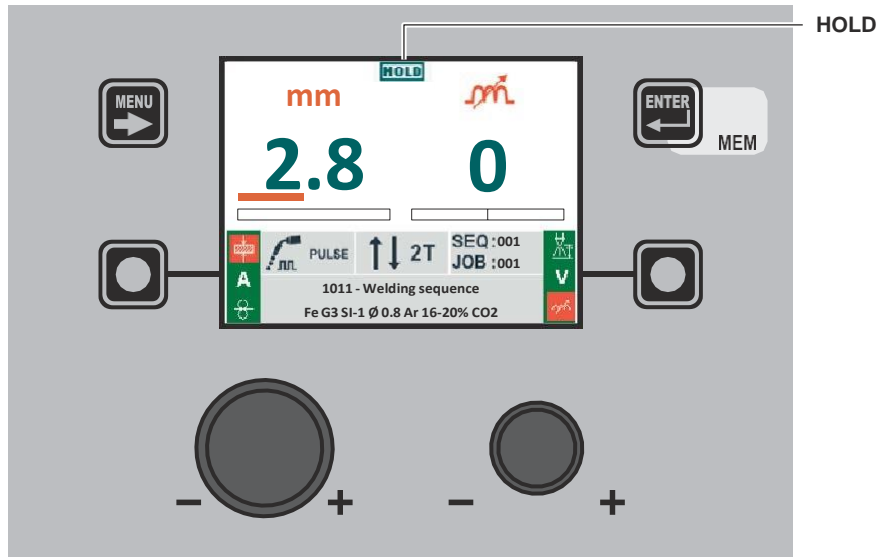

Wire Feeder CONTROL PANEL

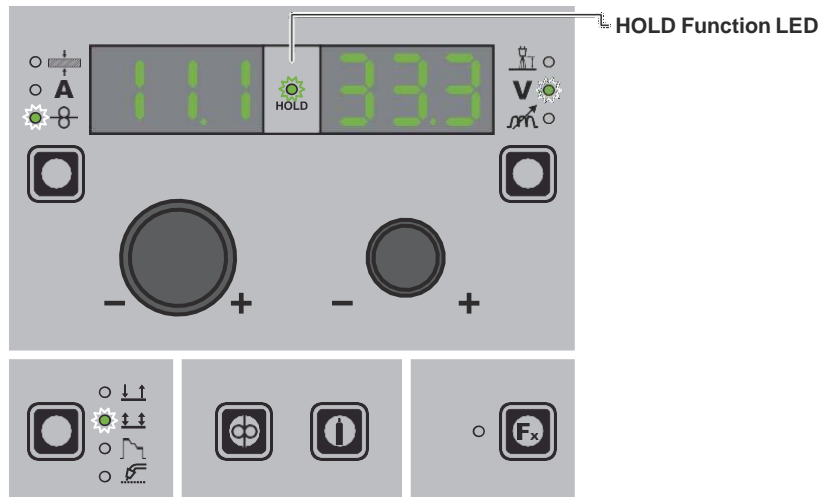

## Error condition

**WARNING:** Under normal conditions of use it is not possible to open the “ERROR LOG Menu” display since the alarm message appears instantaneously on the **VISION SCREEN** as soon as the problem arises on the welding plant. **At this stage it is not possible to weld!**

As soon as the error message appears:

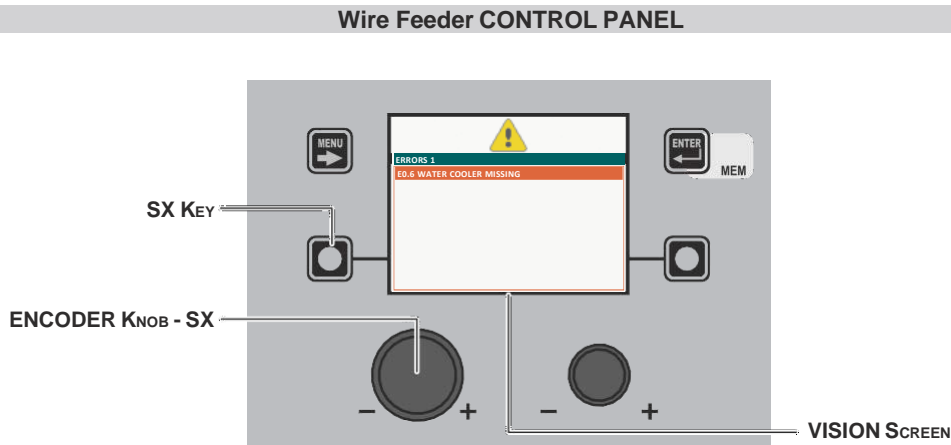

<b>SX KEY</b>	If held down for a period of about <b>5</b> consecutive seconds it takes the <b>VISION SCREEN</b> to the <b>SETUP Menu</b> .
<b>ENCODER KNOB - SX</b>	Used to scroll the alarms activated.
<b>VISION SCREEN</b>	Shows the alarm signal (⚠), number of the errors that have occurred (e.g. ERRORS 1) and an indication of what happened (e.g. E.06 WATER COOLER MISSING) of the welding machine.

In the case of an **Automatically reset error** once the alarm condition has ended (reinstatement completed correctly), the welding plant is once again ready and the operator can recommence welding! The alarm state disappears and the **VISION SCREEN** returns to precisely the same point at which it was operating previously.

**PLEASE NOTE:** After resetting has been completed, during normal operation of the machine, the **VISION SCREEN** will still show the error signal to inform the operator of the event (⚠), but this can be removed visually from the display by simply pushing the **MENU KEY**. **WARNING:** This only removes the visual error indication but not the history of what happened!

In the case of **NON automatically reset errors**, to remove the alarm status and reinstate correct operation of the machine, the welding plant must be switched off.

When it is switched on again, the machine will be working again and the operator can weld again!

**PLEASE NOTE: If, when switching on, the error status presents itself again, immediately contact's Technical Assistance Department.**

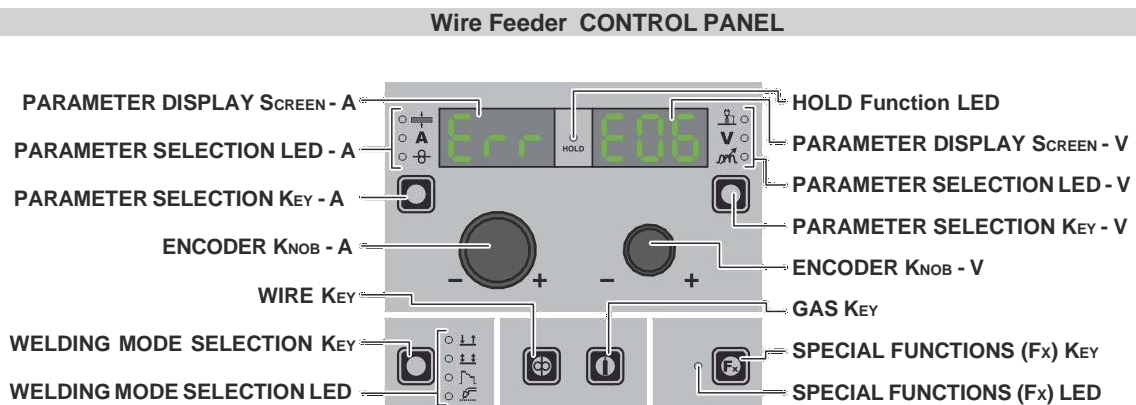

<b>PARAMETER DISPLAY SCREEN - A</b>	Displays the error message (e.g. Err.).
<b>PARAMETER DISPLAY SCREEN - V</b>	Shows the alarm code (e.g. E0.6) of in succession, the codes for the alarms in succession if there are a number of errors.

In the case of an **Automatically reset error** once the alarm condition has ended (reinstatement completed correctly), the welding plant is once again ready and the operator can recommence welding! The alarm state disappears and the **VISION SCREEN** returns to precisely the same point at which it was operating previously.

**PLEASE NOTE:** After resetting has been completed, during normal operation of the machine, the **VISION SCREEN** will still show the error signal to inform the operator of the event (⚠), but this can be removed visually from the display by simply pushing the **MENU KEY**. **WARNING:** This only removes the visual error indication but not the history of what happened!

If an **Error NOT automatically resettable** arises, to eliminate the alarm state and reinstate correct functioning of the machine, switch the plant off and then on again, or hold down the **DX KEY**.

When it is switched on again, the machine will be working again and the operator can weld again!

**PLEASE NOTE:** If, when switching on, the error status presents itself again, immediately contact **Technical Assistance Department**.

## SETUP Menu

### Wire Feeder CONTROL PANEL

To access the *SETUP Menu* hold down for at least 5 consecutive seconds the **SX KEY**.

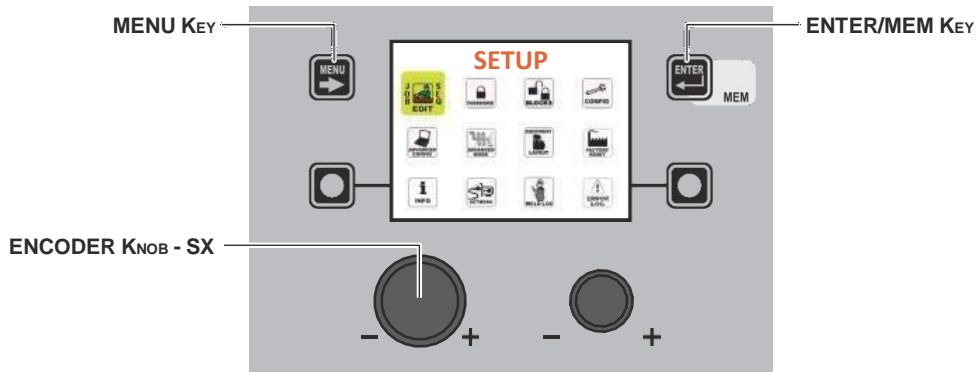

<b>MENU KEY</b>	Used to exit the <i>SETUP Menu</i> and take the <b>VISION SCREEN</b> back to the entry phase.
<b>ENCODER KNOB - SX</b>	Used to scroll the various icons (sub-menus) in the menu and then select them.
<b>ENTER/MEM KEY</b>	Used to access the menu related to the icon selected.

#### **WARNING:**

- It is impossible to weld!
- If the **VISION SCREEN** is protected by a password, access to this menu will only be allowed by entering the correct password.

The icons (sub-menus) available and that can be viewed within the *SETUP Menu* are:

- JOB EDIT
- PASSWORD
- BLOCKS
- CONFIG
- FACTORY RESET
- INFO
- NETWORK
- ERROR LOG

### ACCESSING THE SUB-MENUS



To access the sub-menus included in the *SETUP Menu*, you must:

- Turn the **ENCODER KNOB - SX** to select the desired icon.
- Push the **ENTER/MEM KEY**.

### Wire Feeder CONTROL PANEL

It is not possible to access the *SETUP Menu* and all the related sub-menus using the **Wire Feeder** control panel.

The purpose of this menu is to allow the operator to copy or delete a *JOB* (automatic welding point) entered previously.

To access the *JOB EDIT Menu* from the *SETUP Menu*:

- Turn the **ENCODER KNOB - SX** to select the desired icon.
- Push the **ENTER/MEM KEY**.



**COPYING THE JOB SELECTED**

PRG	JOB	PROCESS	I
01	MMA		97
02	0011 MIG/MAG SYNERGIC		211
03	MMA		97
004	---	---	---
005	---	---	---
006	---	---	---

COPY JOB 002

- To copy the *JOB* selected, proceed as follows:
- Select the *JOB* to be copied by rotating the **ENCODER KNOB - SX**.
  - Push the **SX KEY**.
  - Choose the position to which the *JOB* selected is to be copied (or overwritten \*) by rotating the **ENCODER KNOB - SX**.
  - Push the **ENTER/MEM KEY** to confirm and finalise copying of the *JOB* selected.

\* In the case of overwriting, confirmation will be requested.

**DELETING THE JOB SELECTED**

PRG	JOB	PROCESS	I
01	MMA		97
02	0011 MIG/MAG SYNERGIC		211
03	MMA		97

DELETE JOB 004?

- To delete the *JOB* selected, proceed as follows:
- Select the *JOB* to be deleted by rotating the **ENCODER KNOB - SX**.
  - Push the **DX KEY**.
  - Push the **SX KEY** to confirm and finalise deletion of the *JOB* selected.
  - To cancel the operation of deleting the *JOB* selected, push the **DX KEY**.

To exit the *JOB EDIT Menu* and go back to the *SETUP Menu*:

- Push the **MENU KEY**.

The purpose of this menu is to allow the operator to create, copy, overwrite, or delete a welding sequence.

To access the *SEQ EDIT Menu* from the *SETUP Menu*:

- Turn the **ENCODER KNOB - SX** to select the desired icon.
- Push the **ENTER/MEM KEY**.

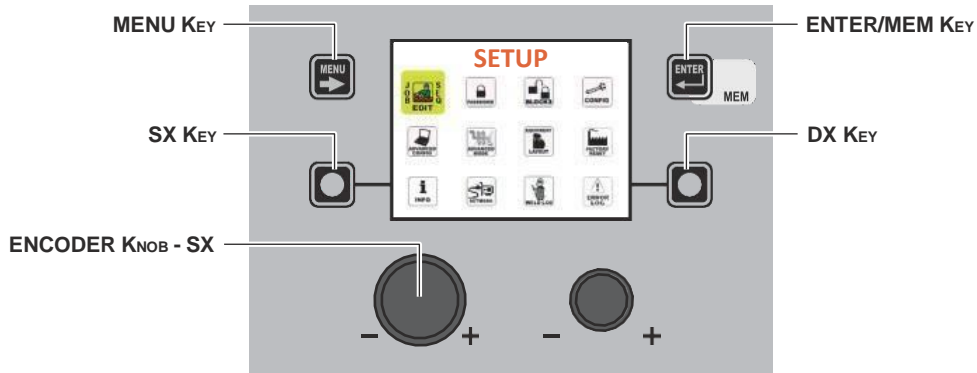

- Turn the **ENCODER KNOB - SX** to select the desired icon.
- Push the **ENTER/MEM KEY**.

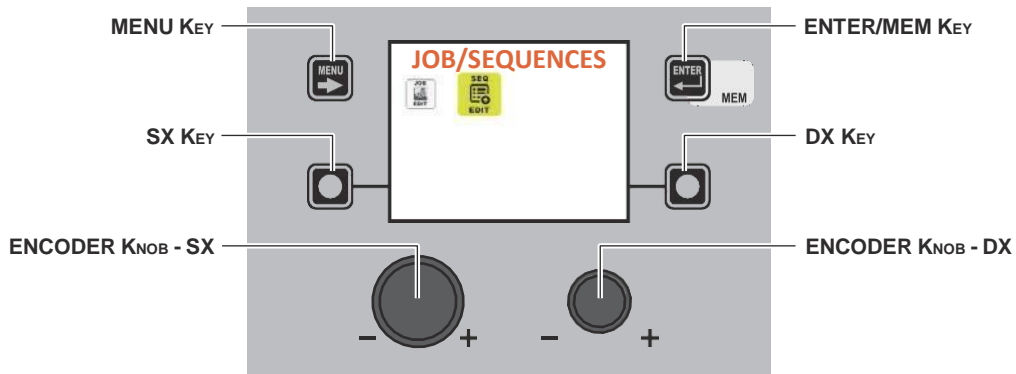

The following image appears:

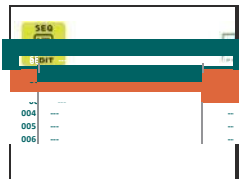

CREATING A SEQUENCE																													
<table border="1"> <thead> <tr> <th>SEQ</th> <th>001</th> <th>NAME</th> <th></th> </tr> <tr> <th>JOB</th> <th>PRG</th> <th>PROCESS</th> <th>SYN</th> </tr> </thead> <tbody> <tr> <td>---</td> <td>---</td> <td>---</td> <td>---</td> </tr> <tr> <td colspan="4">AVAILABLE JOBS: 5</td> </tr> <tr> <td>01</td> <td>1011</td> <td>MIG PULSE</td> <td>100A</td> </tr> <tr> <td>02</td> <td>7011</td> <td>VISION, ULTRASPEED</td> <td>124A</td> </tr> <tr> <td>03</td> <td>2011</td> <td>MIG DUAL PULSE</td> <td>100A</td> </tr> </tbody> </table>	SEQ	001	NAME		JOB	PRG	PROCESS	SYN	---	---	---	---	AVAILABLE JOBS: 5				01	1011	MIG PULSE	100A	02	7011	VISION, ULTRASPEED	124A	03	2011	MIG DUAL PULSE	100A	<p>Use the <b>ENTER/MEM KEY</b> to create a new sequence.</p>
SEQ	001	NAME																											
JOB	PRG	PROCESS	SYN																										
---	---	---	---																										
AVAILABLE JOBS: 5																													
01	1011	MIG PULSE	100A																										
02	7011	VISION, ULTRASPEED	124A																										
03	2011	MIG DUAL PULSE	100A																										
<table border="1"> <thead> <tr> <th>SEQ</th> <th>001</th> <th>NAME</th> <th></th> </tr> <tr> <th>JOB</th> <th>PRG</th> <th>PROCESS</th> <th>SYN</th> </tr> </thead> <tbody> <tr> <td>---</td> <td>---</td> <td>---</td> <td>---</td> </tr> <tr> <td colspan="4">AVAILABLE JOBS: 5</td> </tr> <tr> <td>003</td> <td>1011</td> <td>MIG PULSE</td> <td>100A</td> </tr> </tbody> </table>	SEQ	001	NAME		JOB	PRG	PROCESS	SYN	---	---	---	---	AVAILABLE JOBS: 5				003	1011	MIG PULSE	100A	<p>Use the <b>SX KEY</b> to add the <b>JOB</b> selected using the <b>ENCODER KNOB - DX</b> to the section of the sequence selected using the <b>ENCODER KNOB - SX</b>. The image shows the two jobs (001 and 003) added to the sequence. The yellow colour indicates that the <b>JOBS</b> have already been used. The <b>JOBS</b> already used can be used again in other sections of the sequence.</p>								
SEQ	001	NAME																											
JOB	PRG	PROCESS	SYN																										
---	---	---	---																										
AVAILABLE JOBS: 5																													
003	1011	MIG PULSE	100A																										

(continua)



SEQ	PRG	NAME	SYN
001	1011	MIG PULSE	100A
003	1011	MIG DUAL PULSE	100A
...	...	...	...

AVAILABLE JOBS: 5			
001	1011	MIG PULSE	100A
002	7011	VISION.ULTRASPEED	124A
003	1011	MIG PULSE	100A

Use the **DX Key** to remove the JOB from the section of the sequence selected using the **ENCODER K<sub>NOB</sub> - SX**.  
Push the **ENTER/MEM Key** to be able to edit the sequence name.

SEQ	NAME	# JOB
001	Welding sequence	2
002	---	---
003	---	---
004	---	---
005	---	---
006	---	---

Use the **ENCODER K<sub>NOB</sub> - DX** and the **ENCODER K<sub>NOB</sub> - SX SX** respectively to select the which of the characters available is required, and to move to the position of the next or the previous character. Once creation of the sequence has been completed, push the **MENU Key** to save it.

As you can see, the sequence number is shown on the left, the name of the sequence in the centre, and the total number of jobs used for the sequence on the right.  
Once the welding sequence has been created, the **SX Key** can be used to copy it, the **DX Key** to delete it, or the **ENTER/MEM Key** to edit it.

### COPYING A SEQUENCE

SEQ	NAME	# JOB
001	Welding sequence	2
002	Welding sequence 1	4
003	---	---
004	Welding sequence 2	4
005	---	---
006	---	---

Select the sequence to be copied using the **ENCODER K<sub>NOB</sub> - SX** and push the **SX Key**.

SEQ	NAME	# JOB
001	Welding sequence	2
002	Welding sequence 1	4
003	---	---
004	Welding sequence 2	4
005	---	---
006	---	---

COPY SEQ, 004

The copy sequence 004 message displayed indicates that sequence 4 has been selected.

SEQ	NAME	# JOB
001	Welding sequence 1	2
002	---	---
003	---	---
004	Welding sequence 2	4
005	---	---
006	---	---
007	---	---

COPY SEQ, 004

Select the position of the sequence to be added, using the **ENCODER K<sub>NOB</sub> - SX** (e.g. in this case, position 6).  
Until the **DX Key** is pushed of a new sequence is selected using the **SX Key**, sequence 004 can be added in all the positions it is required.

SEQ	NAME	# JOB
002	Welding sequence 1	2
003	---	---
004	Welding sequence 2	4
005	---	---
006	Welding sequence 2	4
007	---	---

COPY SEQ, 004

Push the **ENTER/MEM Key** to copy the sequence.

SEQ	NAME	# JOB
002	Welding sequence 1	2
003	---	---
004	Welding sequence 2	4
005	---	---
006	Welding sequence 2	4
007	---	---

OVERWRITE SEQ, 006 WITH SEQ, 004?

If the sequence position chosen is already in use, when the **ENTER/MEM Key** is pushed the image to the left is displayed.  
Push the **SX Key** and sequence 4 6 will be replaced by sequence 4, whereas the **DX Key** cancels everything.

### DELETING A SEQUENCE

SEQ	NAME	# JOB
001	Welding sequence	2
002	Welding sequence 1	4
003	---	---
004	Welding sequence 2	4
005	---	---
006	Welding sequence 2	4

Select the sequence to be deleted using the **ENCODER K<sub>NOB</sub> - SX** and push the **SX Key**.

(continua)

	<p>Confirm using the <b>SX KEY</b> or cancel using the <b>DX KEY</b>.</p>
--	---

**EDITING A SEQUENCE**

	<p>Select the position of the sequence to be edited using the <b>ENCODER KNOB - SX</b> and push the <b>ENTER/MEM KEY</b>. The sequence to be edited will be displayed, with all already described for creating the sequence.</p>
--	--

To exit the *JOB EDIT Menu* and go back to the *SETUP Menu*:

- Push the **MENU KEY**.

<b>PASSWORD</b>	<b>SETUP Menu</b>
-----------------	-------------------

The purpose of this menu is to allow the operator to enter a *PASSWORD* for accessing the *SETUP Menu*.

To access the *PASSWORD Menu* from the *SETUP Menu*:

- Turn the **ENCODER KNOB - SX** to select the desired icon.
- Push the **ENTER/MEM KEY**.

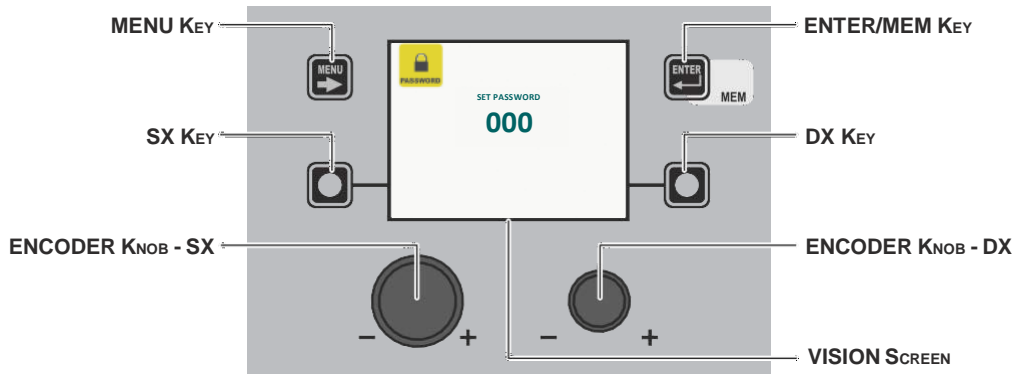

The **VISION SCREEN** can have various configurations, the meaning of which is indicated in the table below.

Display VISION DESCRIPTION	Meaning
000	The <i>SETUP Menu</i> <b>ARE NOT</b> protected by any <i>PASSWORD</i> .
***	The <i>SETUP Menu</i> <b>ARE</b> protected by any <i>PASSWORD</i> .
Number between 001 and 999	The <i>SETUP Menu</i> <b>ARE</b> protected by a <i>PASSWORD</i> and this can be seen by the operator only because they are working inside the <i>SETUP Menu</i> .

**ENTERING A NEW PASSWORD**

	<p>To enter a new <i>PASSWORD</i> proceed as follows:</p> <ul style="list-style-type: none"> <li>• Make sure that the <b>VISION SCREEN</b> displays the text <b>000</b>.</li> <li>• Choose the new <i>PASSWORD</i> to be entered by rotating the <b>ENCODER KNOB - DX</b>.</li> <li>• Push the <b>ENTER/MEM KEY</b> to confirm the operation of entering the <i>PASSWORD</i>.</li> <li>• Push the <b>SX KEY</b> to confirm and finalise entering of the new <i>PASSWORD</i>.</li> <li>• To cancel the operation of entering a <i>PASSWORD</i> push the <b>DX KEY</b>.</li> </ul>
--	--

*(continued)*

## EDITING THE EXISTING PASSWORD

	<p><b>WARNING:</b> This operation is only possible after having accessed the <i>SETUP Menu</i> using the password you wish to edit!</p> <p>To edit the existing <i>PASSWORD</i> proceed as follows:</p> <ul style="list-style-type: none"> <li>• Make sure the <b>VISION SCREEN</b> shows the <i>PASSWORD</i> entered previously (a number that must be between <b>001 and 999</b>).</li> <li>• Choose the new <i>PASSWORD</i> to be entered by rotating the <b>ENCODER KNOB - DX</b>.</li> <li>• Push the <b>ENTER/MEM KEY</b> to confirm the operation of editing the <i>PASSWORD</i>.</li> <li>• Push the <b>SX KEY</b> to confirm and finalise editing of the <i>PASSWORD</i>.</li> <li>• To cancel the operation of editing a <i>PASSWORD</i> push the <b>DX KEY</b>.</li> </ul>
---	---

## DELETING THE EXISTING PASSWORD

	<p><b>WARNING:</b> This operation is only possible after having accessed the <i>SETUP Menu</i> using the password you wish to delete!</p> <p>To delete the existing <i>PASSWORD</i> proceed as follows:</p> <ul style="list-style-type: none"> <li>• Make sure the <b>VISION SCREEN</b> shows the <i>PASSWORD</i> entered previously (a number that must be between <b>001 and 999</b>).</li> <li>• Take the <b>VISION SCREEN</b> to number <b>000</b> by rotating the <b>ENCODER KNOB - DX</b>.</li> <li>• Push the <b>ENTER/MEM KEY</b> to confirm the deletion of the <i>PASSWORD</i>.</li> <li>• Push the <b>SX KEY</b> to confirm and finalise deleting of the <i>PASSWORD</i>.</li> <li>• To cancel the operation of deleting a <i>PASSWORD</i> push the <b>DX KEY</b>.</li> </ul>
---	--

To exit the *PASSWORD Menu* and go back to the *SETUP Menu*:

- Push the **MENU KEY**.

## BLOCKS

## SETUP Menu

The purpose of this menu is to allow the operator to block or limit use of the welding machine and/or certain welding parameters / functions.

To access the *BLOCKS Menu* from the *SETUP Menu*:

- Turn the **ENCODER KNOB - SX** to select the desired icon.
- Push the **ENTER/MEM KEY**.

The image graphically shows how the type of block is shown on the **VISION SCREEN** when the welding machine is operating normally.

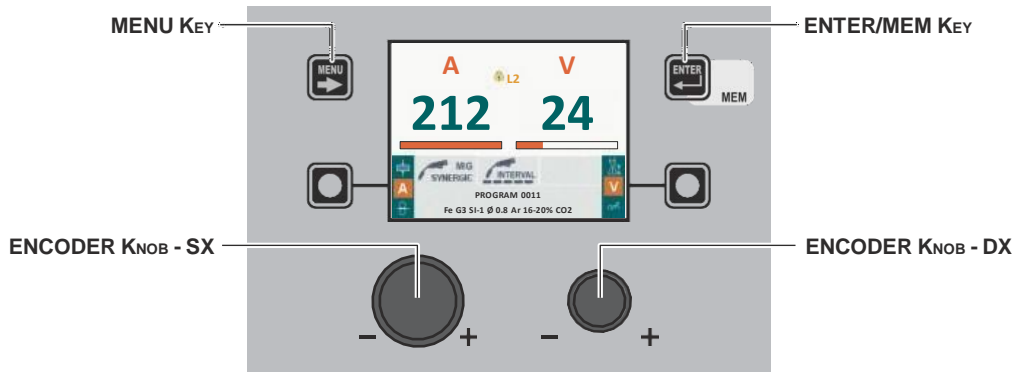

Within the *BLOCKS Menu* it is possible to select, by rotating the **ENCODER KNOB - DX**, the block required (this operation does not require confirmation) from the 4 options available:

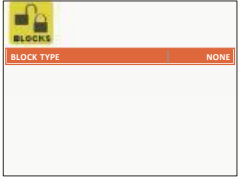
Block type	Description
<p>NONE</p> <div style="border: 1px solid black; padding: 5px; margin: 5px 0;">  </div>	<p><b>BLOCK ABSENT</b> or <b>RELEASE MACHINE</b> Does not allow any block to be activated on the welding machine, but allows the operator to release the machine if its was blocked previously.</p>

*(continued)*

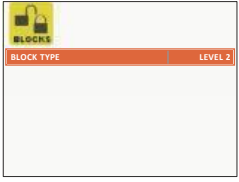
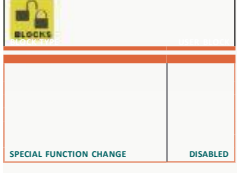
Block type	Description
<p>LEVEL 1</p> 	<p><b>PARTIAL BLOCK</b> The operator can weld using the parameters set prior to the block and may make adjustments and/or changes to the welding parameters using the knobs on the control panels on the welding machine and the wire feeder (if fitted).</p>
<p>LEVEL 2</p> 	<p><b>TOTAL BLOCK</b> The operator can weld only using the parameters set prior to the block and cannot adjust and/or edit the welding parameters.</p>
<p>USER BLOCK</p> 	<p><b>PERSONALISED BLOCK</b> Used to block or limit some adjustments and/or functions of the welding machine.</p>

To exit the *BLOCKS Menu* and go back to the *SETUP Menu*:

- Push the **MENU KEY**.

## CONFIG

## SETUP Menu

The purpose of this menu is to allow the operator to select the language used for the **VISION SCREEN**, change the *SETTINGS menu* to *ADVANCED SETTINGS menu*, enter advanced welding mode, set how cooling is managed, and set wire loading via the torch button.

To access the *CONFIG Menu* from the *SETUP Menu*:

- Turn the **ENCODER KNOB - SX** to select the desired icon.
- Push the **ENTER/MEM KEY**.

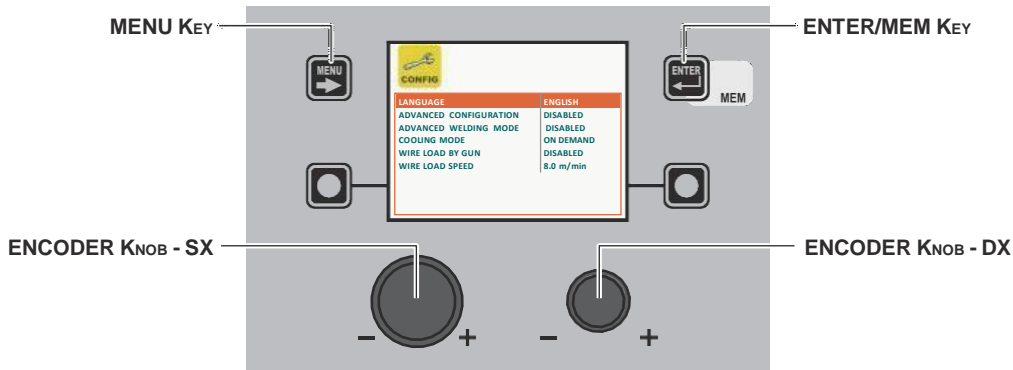

When the *CONFIG Menu* is open, the **ENCODER KNOB - SX** can be rotated to select the which of the 6 functions available is required. This can be enabled (**the operation does not require confirmation**) by rotating the **ENCODER KNOB - DX**.

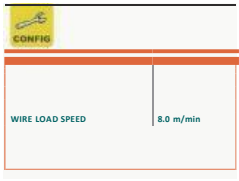
Advanced function	Description
<p>LANGUAGE</p> 	<p>Indicates the languages that can be set for the <b>VISION SCREEN</b>. As regards the procedure for selecting a language on the <b>VISION SCREEN</b> see the relevant paragraph in the manual ("Language Selection").</p>

(continued)

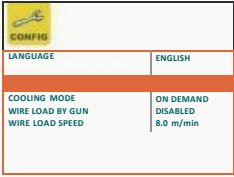
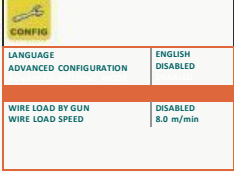
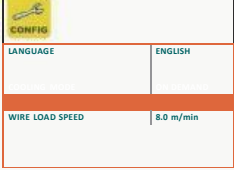
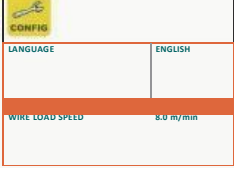
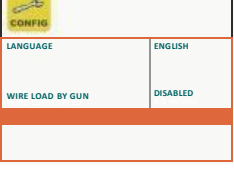
Advanced function	Description
<p>ADVANCED CONFIGURATION</p> 	<p>If enabled, this configuration offers the welder the following additional menus (the following icons will be created in the <i>ADVANCED SETUP Menu</i>):</p> <ul style="list-style-type: none"> <li>• ADVANCED CONFIG</li> <li>• WELD LOG</li> </ul>
<p>ADVANCED WELDING MODE</p> 	<p>If enabled, this configuration allows the welder to have further welding modes available to them (the following icons will be created in the <i>ADVANCED SETUP Menu</i>):</p> <ul style="list-style-type: none"> <li>• ADVANCED MODE</li> </ul>
<p>COOLING MODE</p> 	<p>This configuration allows the welder to set cooling as follows:</p> <ul style="list-style-type: none"> <li>• WHEN REQUESTED. In this case, cooling is managed in relation to the welding done.</li> <li>• ALWAYS ON. In this case, cooling comes on when the machine is switched on, and stays on until the machine is switched off. Cooling only stops when an alarm is activated.</li> </ul>
<p>WIRE LOAD BY GUN</p> 	<p>This configuration allows the welder to enable or disable the type of wire loading from the torch:</p> <ul style="list-style-type: none"> <li>• ACTIVE. In this case wire loading is activated from the torch (also see relevant section).</li> <li>• NOT ACTIVE. In this case, wire loading can only be done using the relevant button on the feeder.</li> </ul>
<p>WIRE LOAD SPEED</p> 	<p>The parameter is used to set the loading speed, both for the torch (if active) and for the feeder. The range for this parameter is 1,0 m/min to 22,0 m/min.</p>

**WARNING:** The additional menus are explained in the manual, in the “*ADVANCED SETUP Menu*” paragraph.

To exit the *CONFIG Menu* and go back to the *SETUP Menu*:

- Push the **MENU KEY**.

The purpose of this menu is to allow the operator to return the welding machine partially or totally to the factory settings.

To access the *FACTORY RESET Menu* from the *SETUP Menu*:

- Turn the **ENCODER KNOB - SX** to select the desired icon.
- Push the **ENTER/MEM KEY**.

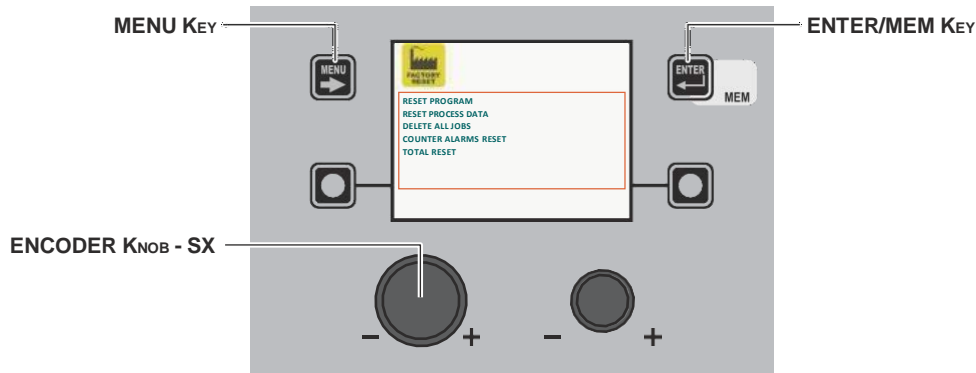

Within the *FACTORY RESET Menu* it is possible, by rotating the **ENCODER KNOB - SX**, to select the individual *RESET* required, from the 5 functions available:

Function	Description
<p><b>RESET PROGRAM</b></p>	<p>Used to return the <i>Special functions (Fx)</i> of the PROGRAM that the operator is using to their DEFAULT settings (only for welding processes for which welding programs are set beforehand).</p> <p><b>NOTE:</b> The welding PROGRAM NUMBER for which the Special Functions (Fx) are to be returned to the factory settings is indicated on the <b>VISION SCREEN</b>.</p>
<p><b>RESET PROCESS DATA</b></p>	<p>Used to return the <i>Special functions (Fx)</i> of the welding PROCESS the operator is using to their DEFAULT settings.</p> <p><b>NOTE:</b> The welding PROCESS for which the Special Functions (Fx) are to be returned to the factory settings, is indicated on the <b>VISION SCREEN</b>.</p>
<p><b>DELETE ALL JOBS</b></p>	<p>Used to delete all the JOBS saved previously by the operator.</p> <p><b>WARNING:</b> Remember that, when it leaves the factory the welding machine DOES NOT HAVE any JOB saved in it!</p>
<p><b>COUNTER ALARMS RESET</b></p>	<p>Used to reset the counters for all the alarms (Curr. - Tot----- see <i>ERROR LOG Menu</i>) that have occurred in the welding plant.</p> <p><b>WARNING:</b> This operation resets the counters for the alarms but does not delete the individual alarms!</p>
<p><b>TOTAL RESET</b></p>	<p>Used to return the welding plant to the factory settings.</p> <p><b>WARNING:</b> Resetting will take place as soon as the key is released to confirm the operation!</p>

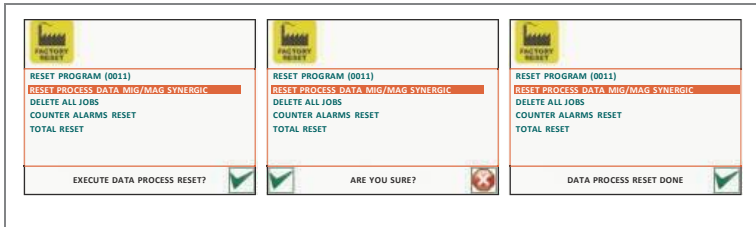

All the functions included in this menu can be used as follows:

- Choose the function (e.g. RESET PROCESS DATA) that you intend to use by rotating the **ENCODER KNOB - SX**.
- EXECUTE PROCESS DATA RESETTING by pushing the **DX Key**.
- PROCEED by finalising the reset by pushing the **SX Key** or cancel the operation by pushing the **DX Key**.

To exit the *FACTORY RESET Menu* and go back to the *SETUP Menu*:

- Push the **MENU Key**.

## INFO SETUP Menu

The purpose of this menu is to allow the operator to know what version of the software has been loaded into each component that is part of the welding plant.

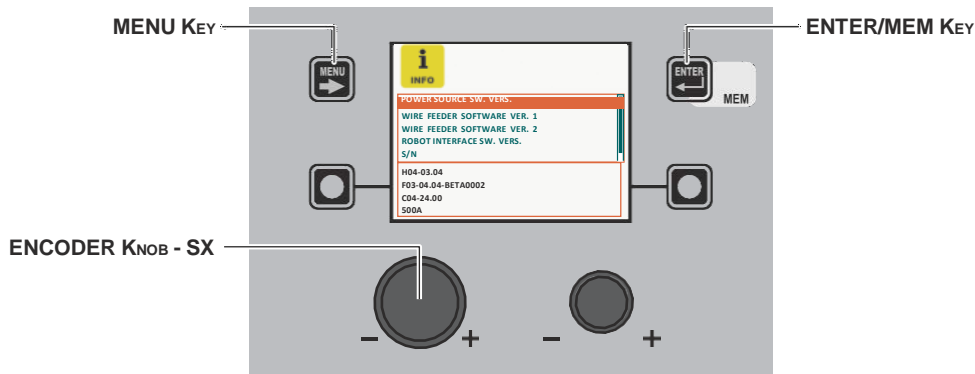

To access the *INFO Menu* from the *SETUP Menu*:

- Turn the **ENCODER KNOB - SX** to select the desired icon.
- Push the **ENTER/MEM Key**.

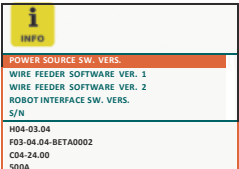
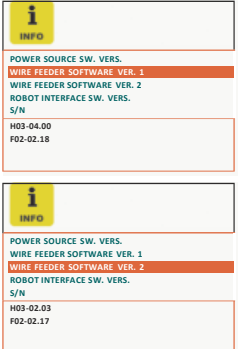

Software	Description
<p>POWER SOURCE SW. VERS.</p> 	Indicates the version of the software loaded into the welding machine.
<p>WIRE FEEDER SOFTWARE VERS. 1/2</p> 	This indicates the software version loaded in feeder 1/2, if applicable.

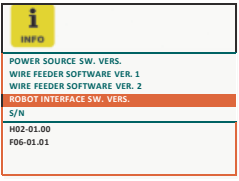
(continued)

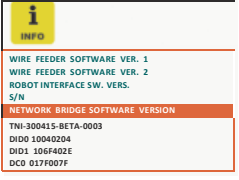
Software	Description
ROBOT INTERFACE SW. VERS. 	This indicates the software version loaded in the robot interface board, if applicable.
S/N 	This indicates the serial number for the microprocessor contained in the digital interface board. This is the serial number required for loading special functions at additional cost.
NETWORK BRIDGE SOFTWARE VERSION 	This indicates the network interface software version loaded in the board. There are also identity codes that are only required for assistance and can be requested if the network malfunctions.

A diagnostics menu can also be accessed by holding down the **DX KEY** and the **DX KEY** for three seconds.

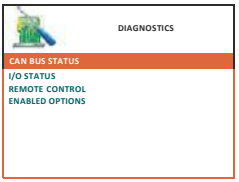
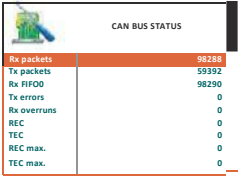
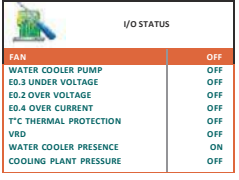
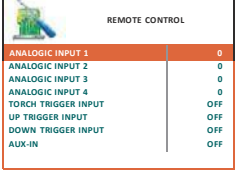
Software	Descrizione
DIAGNOSTICS MENU 	This menu has 4 diagnostics windows: <ul style="list-style-type: none"> <li>• CAN BUS STATUS</li> <li>• I/O STATUS</li> <li>• REMOTE CONTROLS STATUS</li> <li>• ENABLED OPTIONS</li> </ul>
CAN BUS STATUS 	Number of packages transmitted and received (Rx.. and TX..) and the number of transmission errors.
I/O STATUS 	The status of the inputs and outputs on the generator.
REMOTE CONTROLS STATUS 	The status of the inputs: <ul style="list-style-type: none"> <li>• ANALOGUE INPUT 1 (synergic remote-control input)</li> <li>• ANALOGUE INPUT 2 (arc length remote control input)</li> <li>• ANALOGUE INPUTS 3 &amp; 4 not connected</li> <li>• TORCH BUTTON</li> <li>• UP AND DOWN BUTTONS on the torch</li> <li>• AUX-IN not connected</li> </ul>

(continua)

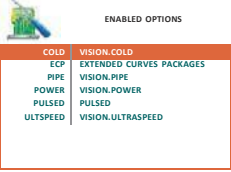

Software	Descrizione
<p>ENABLED OPTIONS</p> 	<p>The special programs enabled, specifically:</p> <ul style="list-style-type: none"> <li>• PULSED</li> <li>• ECP estended curves package</li> <li>• VISION.COLD</li> <li>• VISION.PIPE</li> <li>• VISION.POWER</li> <li>• VISION.ULTRASPEED</li> </ul>

The contents of this menu are for information only, the operator cannot change anything they can only read the information contained by scrolling the various options available in the menu by rotating the **ENCODER KNOB - SX**.

To exit the *INFO Menu* and go back to the *SETUP Menu*:

- Push the **MENU KEY**.

## NETWORK SETUP Menu

This menu is used to view the settings for the Ethernet network if connected. If not, the following image is displayed:

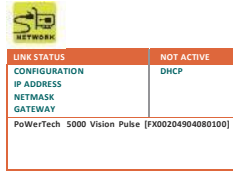

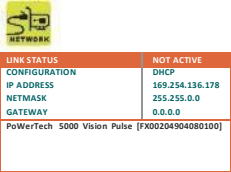
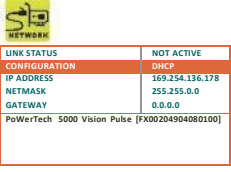
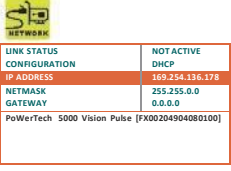
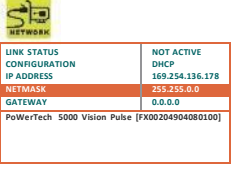
Function	Description
<p>LINK STATUS</p> 	<p>This indicates that the welding machine has an active connection to the Ethernet network.</p>
<p>CONFIGURATION</p> 	<p>This indicates the type of network configuration used. The DHCP protocol is obligatory.</p>
<p>IP ADDRESS</p> 	<p>This indicates the IP address to which the welding machine has been assigned.</p>
<p>NETMASK</p> 	<p>This indicates the sub-network template number to which the welding machine has been assigned.</p>

(continued)

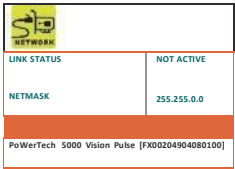
Function	Description
GATEWAY 	This indicates the gateway number to which the welding machine has been assigned.

To exit the *DATA IN-OUT Menu* and go back to the *SETUP Menu*:

- Push the **MENU KEY**.

## ERROR LOG SETUP Menu

The purpose of this menu is to allow the operator to know, interpret, and understand error conditions that have occurred or may be encountered on the welding plant.

To access the *ERROR LOG Menu* from the *SETUP Menu*:

- Turn the **ENCODER KNOB - SX** to select the desired icon.
- Push the **ENTER/MEM KEY**.

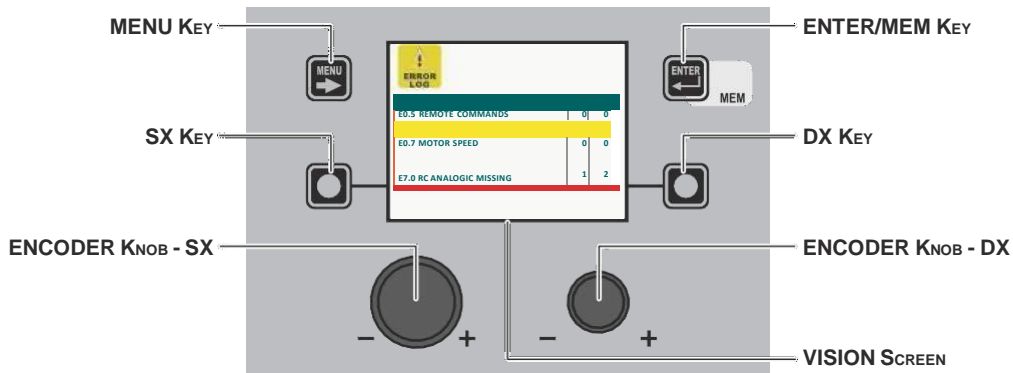

Within the menu the following is indicated for each individual error:

- Its code (e.g. E1.0).
- A short description (e.g. no configuration file).
- The number of times this has occurred since the last time the machine was switched on (Curr).
- The number of times this has occurred since the last ALARM COUNTER RESET or TOTAL RESET (Tot.) of the welding machine.
- Errors that have occurred on the welding plant and subsequently been corrected, but not yet partially reset, are highlighted in yellow.
- Errors that have occurred on the welding machine, but that have not yet been resolved and so are still active, are highlighted in red.

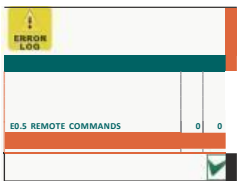
RESET Curr (RESET PARTIAL ERROR COUNT)	
	<p>The counter that indicates how many times a error or alarm has occurred since the last time the machine was switched on is part of this menu, and can be zeroed as follows:</p> <ul style="list-style-type: none"> <li>• Choose the error for which the partial counter (Curr) must be reset by rotating the <b>SX - ENCODER KNOB</b>.</li> <li>• The <b>VISION SCREEN</b> displays an icon in the bottom right corner (see image) that indicates that you can proceed with resetting.</li> <li>• Hold down the <b>DX KEY</b> until resetting of the (Curr) counter has been completed.</li> </ul>

Within the menu, by rotating the **ENCODER KNOB - SX** it is possible to scroll the errors (also indicated in the table below), view them and select them.

Error condition	Error code	Error description and possible diagnosis
Err	E0.0	<b>POWER SUPPLY FAILURE</b> <b>NON automatic reset error.</b> This error can only arise when switching on and not when the welding plant is working normally. Error visible on <b>VISION SCREEN ONLY</b> in the event of a fault and NOT in the <i>ERROR LOG Menu</i> .

(continued)

Error condition	Error code	Error description and possible diagnosis
Err	E0.1	OVER AND UNDER VOLTAGE Automatic reset error.
Err	E0.2	OVER VOLTAGE Automatic reset error.
Err	E0.3	UNDER VOLTAGE Automatic reset error.
Err	E0.4	OVER CURRENT Automatic reset error.
Err	E0.5	REMOTE COMMANDS No feed for remote commands. <b>NON automatic reset error.</b>
Err	E0.6	WATER COOLER MISSING <b>NON automatic reset error.</b> Check that the WATER COOLER SYSTEM - OBLIGATORY function is included within the <i>ADVANCED SETUP Menu / EQUIPMENT LAYOUT</i> . After this initial check you need to know that this error can only occur in the following cases: <ul style="list-style-type: none"> <li>• Water cooler system not connected to the welding machine.</li> <li>• The welding machine does not recognise the water cooler system, even though it is connected correctly.</li> <li>• Water cooler system disconnected when the machine is operating normally.</li> </ul> Once the water cooler system has been reactivated, this error condition <b>resets itself automatically!</b> If the alarm occurs even when the WATER COOLER SYSTEM - OPTIONAL function is included in the <i>ADVANCED SETUP Menu / EQUIPMENT LAYOUT</i> , <b>call Technical Assistance Department immediately.</b>
Err	E0.7	MOTOR FAULT <b>NON automatic reset error.</b> <b>Immediately contact technical assistance dept.</b> Error visible on <b>VISION SCREEN ONLY</b> in the event of a fault and NOT in the <i>ERROR LOG Menu</i> .
Err	E0.8	WIRE FEEDER MISSING <b>NON automatic reset error.</b> Check that the WIRE FEEDER - OBLIGATORY function is included within the <i>ADVANCED SETUP Menu / EQUIPMENT LAYOUT</i> . After this initial check you need to know that this error can only occur in the following cases: <ul style="list-style-type: none"> <li>• Wire feeder not connected to the welding machine.</li> <li>• The welding machine does not recognise the wire feeder, even though it is connected correctly.</li> <li>• Wire feeder disconnected when the machine is operating normally.</li> </ul> Once the wire feeder has been reactivated, this error condition <b>resets itself automatically!</b> If the alarm occurs even when the WIRE FEEDER - OPTIONAL function is included in the <i>ADVANCED SETUP Menu / EQUIPMENT LAYOUT</i> , <b>call Technical Assistance Department immediately.</b>
Err	E0.9	CAN INTERNAL ERROR Faulty communication between the generator and the feeder. <b>NON automatic reset error.</b> Error visible on <b>VISION SCREEN ONLY</b> in the event of a fault and NOT in the <i>ERROR LOG Menu</i> .
Err	T°C	THERMAL PROTECTION The welding stops due to an excessively high temperature (thermostat activated). Automatic reset error.
Err	H20	COOLER PRESSURE The fluid in the cooling system is at low pressure. <b>NON automatic reset error.</b>
Err	E1.0	CONFIG. FILE MISSING <b>NON automatic reset error.</b> <b>Immediately contact technical assistance dept.</b> Error visible on <b>VISION SCREEN ONLY</b> in the event of a fault and NOT in the <i>ERROR LOG Menu</i> .
Err	E1.1	USER FILE MISSING <b>NON automatic reset error.</b> <b>Immediately contact technical assistance dept.</b> Error visible on <b>VISION SCREEN ONLY</b> in the event of a fault and NOT in the <i>ERROR LOG Menu</i> .
Err	E1.2	TORCH FILE MISSING <b>NON automatic reset error.</b> <b>Immediately contact technical assistance dept.</b> Error visible on <b>VISION SCREEN ONLY</b> in the event of a fault and NOT in the <i>ERROR LOG Menu</i> .

(continued)

Error condition	Error code	Error description and possible diagnosis
Err	E1.3	CALIBRATION FILE MISSING <b>NON automatic reset error.</b> <b>Immediately contact technical assistance dept.</b> Error visible on <b>VISION SCREEN ONLY</b> in the event of a fault and NOT in the <i>ERROR LOG Menu</i> .
Err	E1.6	MMA DEFAULTS MISSING <b>NON automatic reset error.</b> <b>Immediately contact technical assistance dept.</b> Error visible on <b>VISION SCREEN ONLY</b> in the event of a fault and NOT in the <i>ERROR LOG Menu</i> .
Err	E1.7	TIG DEFAULTS MISSING <b>NON automatic reset error.</b> <b>Immediately contact technical assistance dept.</b> Error visible on <b>VISION SCREEN ONLY</b> in the event of a fault and NOT in the <i>ERROR LOG Menu</i> .
Err	E1.8	MIG DEFAULTS MISSING <b>NON automatic reset error.</b> <b>Immediately contact technical assistance dept.</b> Error visible on <b>VISION SCREEN ONLY</b> in the event of a fault and NOT in the <i>ERROR LOG Menu</i> .
Err	E1.9	WELDER DEFAULTS MISSING <b>NON automatic reset error.</b> <b>Immediately contact technical assistance dept.</b> Error visible on <b>VISION SCREEN ONLY</b> in the event of a fault and NOT in the <i>ERROR LOG Menu</i> .
Err	E2.0	FILE SYSTEM ERROR <b>NON automatic reset error.</b> <b>Immediately contact technical assistance dept.</b> Error visible on <b>VISION SCREEN ONLY</b> in the event of a fault and NOT in the <i>ERROR LOG Menu</i> .
Err	E3.2	STICKING This error is displayed when a short-circuit has been formed between the machine's output terminals for more than 1.2 seconds. <b>NON automatic reset error.</b> To remove the error state, eliminate the short circuit so that the voltage on the torch goes above the threshold value again. At this stage the error condition disappears, and the welding machine goes back to the mode prior to the sticking. If the torch trigger is still pushed, it must be released and pressed again to begin welding again.
Err	E3.3	MOTOR SPEED FAULT <b>NON automatic reset error.</b> Check that the rollers on the wire feeder mechanism are not stuck and that the welding wire comes out correctly, otherwise <b>contact Technical Assistance Department immediately.</b>
Err	E4.0	LAST SETUP NOT VALID <b>NON automatic reset error.</b> <b>Immediately contact technical assistance dept.</b> Error visible on <b>VISION SCREEN ONLY</b> in the event of a fault and NOT in the <i>ERROR LOG Menu</i> .
Err	E4.1	JOBS WRONG <b>NON automatic reset error.</b> <b>Immediately contact technical assistance dept.</b> Error visible on <b>VISION SCREEN ONLY</b> in the event of a fault and NOT in the <i>ERROR LOG Menu</i> .
Err	E4.2	MIG SYN SPECIAL FUNCTION (Fx) WRONG <b>NON automatic reset error.</b> <b>Immediately contact technical assistance dept.</b> Error visible on <b>VISION SCREEN ONLY</b> in the event of a fault and NOT in the <i>ERROR LOG Menu</i> .
Err	E4.3	MIG MAN SPECIAL FUNCTION (Fx) WRONG <b>NON automatic reset error.</b> <b>Immediately contact technical assistance dept.</b> Error visible on <b>VISION SCREEN ONLY</b> in the event of a fault and NOT in the <i>ERROR LOG Menu</i> .
Err	E4.4	SPECIAL PULSED MIG FUNCTIONS (Fx) NOT VALID <b>NON automatic reset error.</b> <b>Immediately contact technical assistance dept.</b> Error visible on <b>VISION SCREEN ONLY</b> in the event of a fault and NOT in the <i>ERROR LOG Menu</i> .
Err	E4.5	SPECIAL DOUBLE PULSED MIG FUNCTIONS (Fx) NOT VALID <b>NON automatic reset error.</b> <b>Immediately contact technical assistance dept.</b> Error visible on <b>VISION SCREEN ONLY</b> in the event of a fault and NOT in the <i>ERROR LOG Menu</i> .

(continued)

Error condition	Error code	Error description and possible diagnosis
Err	E5.0	MIG PROGRAMS MISSING <b>NON automatic reset error.</b> <b>Immediately contact technical assistance dept.</b> Error visible on <b>VISION SCREEN ONLY</b> in the event of a fault and NOT in the <i>ERROR LOG Menu</i> .
Err	E5.1	PULSED MIG WELDING PROGRAMMES MISSING <b>NON automatic reset error.</b> <b>Immediately contact technical assistance dept.</b> Error visible on <b>VISION SCREEN ONLY</b> in the event of a fault and NOT in the <i>ERROR LOG Menu</i> .
Err	E5.3	MMA PROGRAMS MISSING <b>NON automatic reset error.</b> <b>Immediately contact technical assistance dept.</b> Error visible on <b>VISION SCREEN ONLY</b> in the event of a fault and NOT in the <i>ERROR LOG Menu</i> .
Err	E5.4	TIG PROGRAMS MISSING <b>NON automatic reset error.</b> <b>Immediately contact technical assistance dept.</b> Error visible on <b>VISION SCREEN ONLY</b> in the event of a fault and NOT in the <i>ERROR LOG Menu</i> .
Err	E5.5	MIG MANUAL PROGRAMS MISSING <b>NON automatic reset error.</b> <b>Immediately contact technical assistance dept.</b> Error visible on <b>VISION SCREEN ONLY</b> in the event of a fault and NOT in the <i>ERROR LOG Menu</i> .
Err	E6.0	Wire Feeder CAN LINK MISSING <b>NON automatic reset error.</b> <b>Immediately contact technical assistance dept.</b>
Err	E6.1	ROBOT LINK MISSING <b>NON automatic reset error.</b> <b>Immediately contact technical assistance dept.</b>
Err	E6.5	NO ROBOT INTERFACE Automatic reset error.
Err	E7.0	RC ANALOGIC MISSING <b>NON automatic reset error.</b> Check that the ANALOGIC RC - OBLIGATORY function is included within the <i>ADVANCED SETUP Menu / EQUIPMENT LAYOUT</i> . After this initial check you need to know that this error can <b>only</b> occur in the following cases: • ANALOGIC RC remote control not connected to the relevant connector. • The welding plant does not recognise the ANALOGIC RC remote control, even though it is connected correctly. • The ANALOGIC RC remote control disconnected when the welding plant is working normally. As soon as the remote control is connected again this error condition <b>resets itself automatically!</b> If the alarm occurs even when the ANALOGIC RC - OPTIONAL function is included in the <i>ADVANCED SETUP Menu / EQUIPMENT LAYOUT</i> , <b>call Technical Assistance Department immediately.</b>
Err	E8.3	NO GAS FLOW Error reset by a command from the robot's board (see robot interface manual).
Err	E8.4	NO H2O FLOW Error reset by a command from the robot's board (see robot interface manual).
Err	E8.7	NO WELDING WIRE Error reset by a command from the robot's board (see robot interface manual).
AUT	ADJ	POWER LIMITATION This alarm appears if the power limit is exceeded. The alarm alternates with the standard display every 1.5 seconds, despite which the machine continues to weld, supplying limited power, but complying with the values shown on the data plate.

The table provides a simple summary of all the error conditions that may arise on the welding plant and, if possible, what the operator must do to attempt to resolve the problem.

The table includes **2** types of errors:

- **Automatic reset error:** Once the alarm condition has been resolved the welding machine starts working again and the operator can weld again! The **VISION SCREEN** goes back to exactly the same point it was at prior to signalling the alarm!  
**PLEASE NOTE:** After resetting has been completed, during normal operation of the machine, the **VISION SCREEN** will still show the error signal to inform the operator of the event (▲), but this can be removed visually from the display by simply pushing the **MENU KEY**.  
**WARNING:** This only removes the visual error indication but not the history of what happened!
- **NON automatic reset error:** To remove the alarm status and reinstate correct operation of the machine, the welding plant must be switched off.  
The machine will then be working again and the operator can weld again!

**PLEASE NOTE: If, when switching on, the error status presents itself again, immediately contact Technical Assistance Department.**

This is necessary so that our technical assistance dept (that must be contacted each time the error messages appear on the welding machine's operator interface) is able to resolve the problems more easily and as quickly as possible, thanks to the reports by the user, and also because, in the meantime the welding machine does not allow the operator to do their work.

To exit the *ERROR LOG Menu* and go back to the *SETUP Menu*:

- Push the **MENU KEY**.

## ADVANCED SETUP Menu

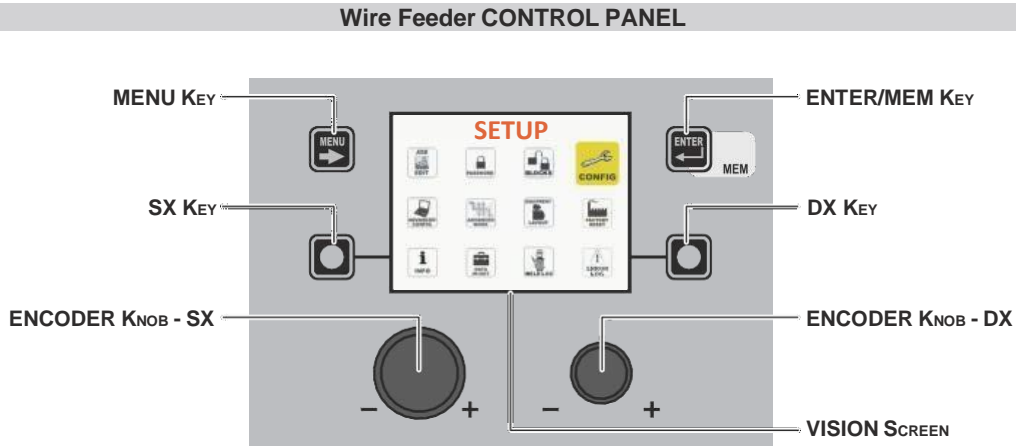

To access the *ADVANCED SETUP Menu* from any point on the control panel:

- Open the *SETUP Menu* by holding the **SX KEY** down for at least 5 consecutive seconds.
- Open the *CONFIG Menu* by rotating the **ENCODER KNOB - SX** until the icon required is reached, and then push the **ENTER/MEM KEY**.
- Access the *ADVANCED CONFIGURATION* function by rotating the **ENCODER KNOB - SX** and select *ACTIVATE* by rotating the **ENCODER KNOB - DX**.
- Access the *ADVANCED WELDING MODE* function by rotating the **ENCODER KNOB - SX** and select *ACTIVATE* by rotating the **ENCODER KNOB - DX**.
- Access the *PLANT CONFIGURATION* function by rotating the **ENCODER KNOB - SX** and select *ACTIVATE* by rotating the **ENCODER KNOB - DX**.
- Exit the *CONFIG Menu* by pushing the **MENU KEY**.
- At this stage the *SETUP Menu* has been transformed into the *ADVANCED SETUP Menu* and the **VISION SCREEN** displays the following additional icons:
  - *ADVANCED CONFIG*
  - *ADVANCED MODE*
  - *EQUIPMENT LAYOUT*
  - *WELD LOG*

<b>MENU KEY</b>	Used to exit the <i>ADVANCED SETUP Menu</i> and take the <b>VISION SCREEN</b> back to the welding phase.
<b>ENCODER KNOB - SX</b>	Used to scroll the various icons (sub-menus) in the menu and then select them.
<b>ENTER/MEM KEY</b>	Used to access the menu related to the icon selected.

### WARNING:

- It is impossible to weld!
- If the **VISION SCREEN** is protected by a password, access to this menu will only be allowed by entering the correct password.

## ACCESSING THE SUB-MENUS



To access the sub-menus included in the *ADVANCED SETUP Menu*, you must:

- Turn the **ENCODER KNOB - SX** to select the desired icon.
- Push the **ENTER/MEM KEY**.

## Wire Feeder CONTROL PANEL

It is not possible to access the *ADVANCED SETUP Menu* and all the related sub-menus using the “Wire Feeder” control panel.

## ADVANCED CONFIG

## ADVANCED SETUP Menu

The purpose of this menu is to allow the operator to know the actual working time and operation of the welding machine, to configure the ENERGY SAVING mode in the best way to allow the best energy saving on the welding plant, and to be able to enable an analogue output on the welding plant that can be used for connecting total remote controls equipped with automatic self-recognition.

To access the *ADVANCED CONFIG Menu* from the *ADVANCED SETUP Menu*:

- Turn the **ENCODER KNOB - SX** to select the desired icon.
- Push the **ENTER/MEM KEY**.

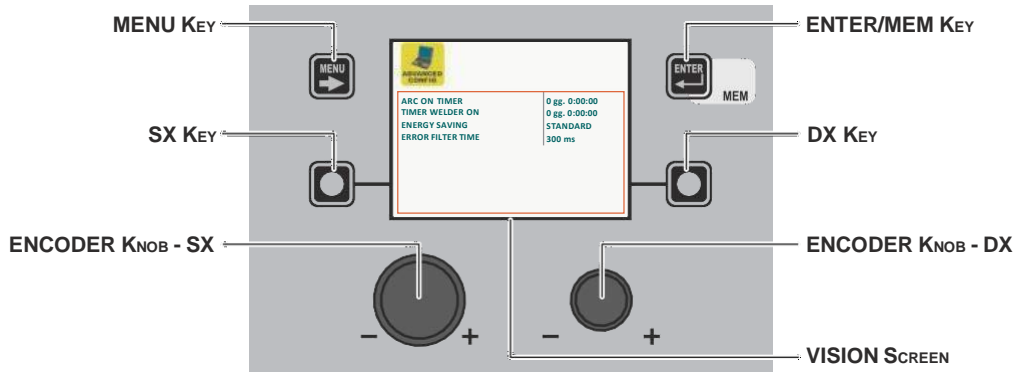

Within the *ADVANCED CONFIG Menu* the operator can view:

Advanced function	Description
<p><b>ARC ON TIMER</b></p>	<p>Indicates the actual time the machine is used for welding.  <b>WARNING:</b> This time can only be zeroed by means of a <b>TOTAL RESET</b> (see the relevant paragraph) of the welding plant.</p>
<p><b>TIME WELDER ON</b></p>	<p>Indicates the actual time the machine works, even when the screen saver is activated.  <b>WARNING:</b> This time can only be zeroed by means of a <b>TOTAL RESET</b> (see the relevant paragraph) of the welding plant.</p>

**WARNING:** The content of the part of the menu described above is for information only, the operator cannot make any changes, they can only view and read the information available on the screen.

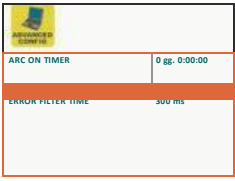
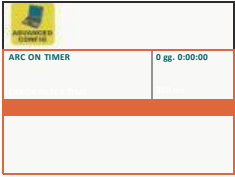
Advanced function	Description
<p>ENERGY SAVING</p> 	<p>By rotating the <b>ENCODER KNOB - DX</b> (this operation does not require confirmation) it is possible to choose the energy saving mode you prefer from the 3 available for the welding plant:</p> <ul style="list-style-type: none"> <li>• <b>STANDARD</b> - Energy saving is achieved by the screen saver being activated for the screens on both the generator and the feeder after a set time that cannot be changed by the operator (see the relevant paragraph).</li> <li>• <b>ULTRA</b> - Energy saving is obtained by the screens on the generator and the feeder being switched off after a set time, equal to that for the screen saver, which cannot be changed by the operator.</li> <li>• <b>EXTRA</b> - Energy saving is obtained by the screens on the generator and the feeder switching off as soon as the machine is switched on.</li> </ul>
<p>ERROR FILTER TIME</p> 	<p>This is used to set the minimum time an alarm remains active before it is displayed.</p>

To exit the *ADVANCED CONFIG Menu* and go back to the *ADVANCED SETUP Menu*:

- Push the **MENU KEY**.

## ADVANCED MODE

## ADVANCED SETUP Menu

The purpose of this menu is to allow the operator to further refine adjustments to the welding parameters for the machine.

To access the *ADVANCED MODE Menu* from the *ADVANCED SETUP Menu*:

- Turn the **ENCODER KNOB - SX** to select the desired icon.
- Push the **ENTER/MEM KEY**.

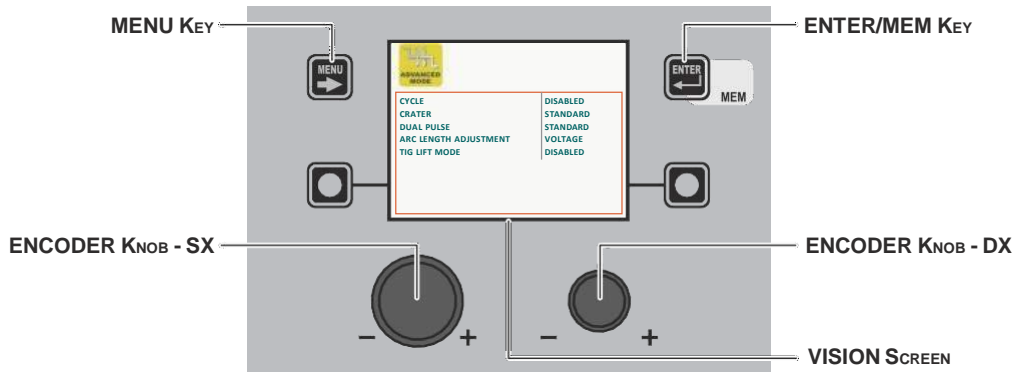



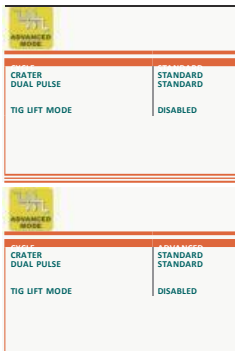

Within the *ADVANCED MODE Menu* it is possible, by rotating the **ENCODER KNOB - SX**, to choose the advanced welding mode required from the 4 available (according to the welding process selected) and this can be **ACTIVATED** (this operation does not require confirmation) by rotating the **ENCODER KNOB - DX**.

Advanced function	Description
<p>CYCLE</p> 	<p>If enabled, when operating in STANDARD or ADVANCED mode, this function provides the operator with a further welding mode (CYCLE) and the special functions associated with it, when using MIG (pulsed, double pulsed, synergic, or manual) welding processes:</p> <ul style="list-style-type: none"> <li>• CURRENT CYCLE, CYCLE WIRE SPEED (see TAB. A/B parameter F19).</li> <li>• CYCLE ARC LENGTH, CYCLE VOLTAGE (see TAB. A/B parameter F20).</li> <li>• FIRST SLOPE (from I1 to I2) see TAB. A/B parameter F18) - advanced cycle only.</li> <li>• SECOND SLOPE (from I2 to I1) (see TAB. A/B parameter F21) - advanced cycle only.</li> </ul> <p>The <i>WELDING MODE SELECTION Menu (MODE)</i> menu will therefore be changed. This function can only be activated, with the above procedure, on the VISION Display, whilst it can also be set on the Wire Feeder drag-and-drop once it is activated. See the special "WELD MODE SELECTION Key" paragraph for correct functioning of the CYCLE welding mode.</p>

(continued)

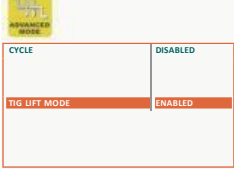

Advanced function	Description
<p>CRATER</p> 	<p>If enabled, when working in ADVANCED mode, this function provides the operator with further welding modes related to the CRATER as well as the <b>2</b> special functions explained below that make it possible to vary the length of the arc in the welding crater, when using MIG (pulsed, double pulsed, synergic, and manual) welding processes.</p> <ul style="list-style-type: none"> <li>• INITIAL ARC LENGTH, INITIAL VOLTAGE (see TAB. A/B parameter F09)</li> <li>• FINAL ARC LENGTH, FINAL VOLTAGE (see TAB. A/B parameter F14)</li> </ul>
<p>DOUBLE PULSED</p> 	<p>If enabled, when working in ADVANCED mode, this function provides the operator with the following special functions, when using the double pulsed MIG welding process:</p> <ul style="list-style-type: none"> <li>• DOUBLE PULSED ARC LENGTH (F24) Allows the welder to adjust the length of the arc on both double pulsed levels.</li> <li>• FIRST SLOPE (from <b>11</b> to <b>12</b>) (see TAB. A parameter F22)</li> <li>• SECOND SLOPE (from <b>12</b> to <b>11</b>) (see TAB. A parameter F27)</li> </ul> <p>These two special functions allow the welder to adjust the ramp for passing between the two double pulsed levels.</p>
<p>ARC LENGTH ADJUSTMENT</p> 	<p>This function allows an operator using the (pulsed, double pulsed, synergic and manual) MIG welding process to adjust the <i>ARC LENGTH ADJUSTMENT</i> (<math>\frac{1}{2}</math>) parameter with the <i>WELDING VOLTAGE</i> (<b>V</b>) or the <i>WIRE SPEED</i> (<math>\frac{1}{8}</math>).</p>
<p>TIG LIFT MODE</p>  <p style="text-align: center;">↓</p> 	<p>If activated, this function makes an additional welding mode known as TIG LIFT TORCH TRIGGER available to an operator using the TIG LIFT welding process. In this mode the welder can control the <i>WELDING CURRENT</i> (<b>A</b>) parameter, using the button on the TIG torch.</p> <p><b>WARNING: To allow TIG LIFT WITH TORCH TRIGGER welding, the DIGITECH PULSE needs a specific female connector to be fitted on it (NON-STANDARD MACHINE) to which the corresponding male connector on the TIG torch is to be connected.</b></p> <p>Therefore, for the TIG LIFT welding process, a new menu will be created (see figure) named <i>WELDING MODE SELECTION Menu (MODE)</i>.</p> <p style="text-align: center;"><b>WELDING MODE SELECTION Menu (MODE)</b></p> <p>To access the <i>WELDING MODE SELECTION Menu (MODE)</i> push the <b>MENU KEY</b>.</p> <p><b>Wire Feeder CONTROL PANEL</b>  <b>MENU KEY</b> - Used to access subsequent menus, where applicable.  <b>ENCODER KNOB - SX</b> - Selects the welding mode.  <b>ENTER/MEM KEY</b> - Used to access the <i>PRE-SETTING</i> for the program selected beforehand, with the welding <i>MODE</i> chosen.</p> <p><b>Wire Feeder CONTROL PANEL</b>  It is not possible to access the <i>WELDING MODE SELECTION Menu (MODE)</i> via the “Wire Feeder” control panel.</p>

To exit the *ADVANCED MODE Menu* and go back to the *ADVANCED SETUP Menu*:

- Push the **MENU KEY**.

The purpose of this menu is to allow the operator to manage connections of components and accessories that are part of the welding plant.

To access the *EQUIPMENT LAYOUT Menu* from the *SETUP Menu*:



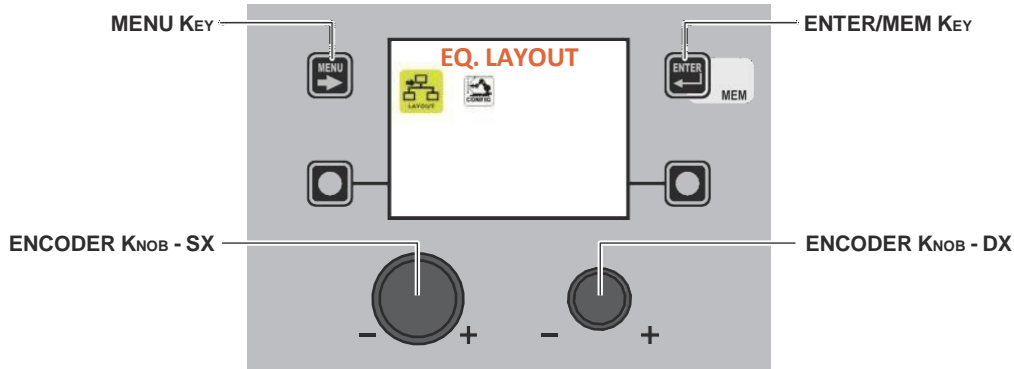

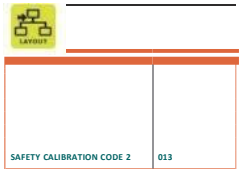
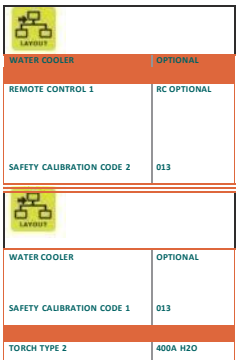

- Turn the **ENCODER KNOB - SX** to select the desired icon.
- Push the **ENTER/MEM KEY**.



Within the *EQUIPMENT LAYOUT Menu*, it is possible, by rotating the **ENCODER KNOB - SX**, to select the component of the welding plant, while by rotating the **ENCODER KNOB - DX**, you can decide the type of connection required (e.g. Optional) or the type of component (e.g. Torch 400 A H2O) that is to be connected to the plant (**this operation does not require confirmation**).

Advanced function	Description
<p><b>WATER COOLER</b></p> 	<p><b>OPTIONAL</b> - Means that the water cooler system may or may not be connected to the welding machine.</p> <p><b>OBLIGATORY</b> - Means that it is obligatory for the water cooler system to be connected to the welding plant. A error condition is generated when:</p> <ul style="list-style-type: none"> <li>• Switching on or at any other time if the welding plant does not detect the presence.</li> <li>• During normal operation if the water cooler system is disconnected.</li> </ul> <p>Also see the CONFIG menu if it is necessary to keep the cooling system working continuously.</p>
<p><b>WIRE FEEDER 1 / WIRE FEEDER 2</b></p> 	<p><b>OPTIONAL</b> - This means that FEEDER 1-2 can or cannot be connected to the welding plant. Once feeder 1-2 is detected when the plant is switched on, its presence becomes obligatory.</p> <p><b>OBLIGATORY</b> - This means that it is obligatory for FEEDER 1-2 to be connected to the welding plant, even when the plant is switched on. A error condition is generated when:</p> <ul style="list-style-type: none"> <li>• When switched on, if the welding plant does not detect its presence.</li> <li>• During normal operation if the wire feeder is disconnected.</li> </ul> <p><b>MISSING</b> - Means that feeder 2 must not be managed by the plant, even if it is connected up. <b>NOTE:</b> <i>If the second feeder is not connected up, all the settings relate to feeder 1.</i> <b>NOTE:</b> <i>The FEEDER 2 section must also be set to allow feeder 2 to work in a robotised plant.</i></p>

(continued)

Advanced function	Description																																				
<p>REMOTE CONTROL 1 / REMOTE CONTROL 2</p>  <table border="1" data-bbox="204 264 432 389"> <tr><td>WATER COOLER</td><td>OPTIONAL</td></tr> <tr><td>WIRE FEEDER 1</td><td>OPTIONAL</td></tr> <tr><td>REMOTE CONTROL 1</td><td>RC OPTIONAL</td></tr> <tr><td>TORCH TYPE 1</td><td>400A H2O</td></tr> <tr><td>SAFETY CALIBRATION CODE 1</td><td>013</td></tr> <tr><td>WIRE FEEDER 2</td><td>ABSENT</td></tr> <tr><td>REMOTE CONTROL 2</td><td>RC OPTIONAL</td></tr> <tr><td>TORCH TYPE 2</td><td>400A H2O</td></tr> <tr><td>SAFETY CALIBRATION CODE 2</td><td>013</td></tr> </table>  <table border="1" data-bbox="204 443 432 568"> <tr><td>WATER COOLER</td><td>OPTIONAL</td></tr> <tr><td>WIRE FEEDER 1</td><td>OPTIONAL</td></tr> <tr><td>REMOTE CONTROL 1</td><td>RC OPTIONAL</td></tr> <tr><td>TORCH TYPE 1</td><td>400A H2O</td></tr> <tr><td>SAFETY CALIBRATION CODE 1</td><td>013</td></tr> <tr><td>WIRE FEEDER 2</td><td>ABSENT</td></tr> <tr><td>REMOTE CONTROL 2</td><td>RC OPTIONAL</td></tr> <tr><td>TORCH TYPE 2</td><td>400A H2O</td></tr> <tr><td>SAFETY CALIBRATION CODE 2</td><td>013</td></tr> </table>	WATER COOLER	OPTIONAL	WIRE FEEDER 1	OPTIONAL	REMOTE CONTROL 1	RC OPTIONAL	TORCH TYPE 1	400A H2O	SAFETY CALIBRATION CODE 1	013	WIRE FEEDER 2	ABSENT	REMOTE CONTROL 2	RC OPTIONAL	TORCH TYPE 2	400A H2O	SAFETY CALIBRATION CODE 2	013	WATER COOLER	OPTIONAL	WIRE FEEDER 1	OPTIONAL	REMOTE CONTROL 1	RC OPTIONAL	TORCH TYPE 1	400A H2O	SAFETY CALIBRATION CODE 1	013	WIRE FEEDER 2	ABSENT	REMOTE CONTROL 2	RC OPTIONAL	TORCH TYPE 2	400A H2O	SAFETY CALIBRATION CODE 2	013	<p>DISABLED - Means that REMOTE CONTROL 1-2 must not be managed by the plant, even if it is connected up.</p> <p>OPTIONAL - This means that REMOTE CONTROL 1-2 can or cannot be connected to the welding plant. If it is disconnected while the plant is running, no alarm is raised.</p> <p>OBLIGATORY - This means that it is obligatory for REMOTE CONTROL 1-2 to be connected to the welding plant, even when the plant is switched on.</p> <p>A error condition is generated when:</p> <ul style="list-style-type: none"> <li>• Switching on or at any other time if the welding plant does not detect the presence (only if set as obligatory).</li> <li>• During normal operation if the remote control is disconnected.</li> </ul> <p><b>WARNING:</b> For indications on use and functioning of the ANALOGIC RC remote control see the manuals for the welding machine and the wire feeder, enclosed with the documentation.</p>
WATER COOLER	OPTIONAL																																				
WIRE FEEDER 1	OPTIONAL																																				
REMOTE CONTROL 1	RC OPTIONAL																																				
TORCH TYPE 1	400A H2O																																				
SAFETY CALIBRATION CODE 1	013																																				
WIRE FEEDER 2	ABSENT																																				
REMOTE CONTROL 2	RC OPTIONAL																																				
TORCH TYPE 2	400A H2O																																				
SAFETY CALIBRATION CODE 2	013																																				
WATER COOLER	OPTIONAL																																				
WIRE FEEDER 1	OPTIONAL																																				
REMOTE CONTROL 1	RC OPTIONAL																																				
TORCH TYPE 1	400A H2O																																				
SAFETY CALIBRATION CODE 1	013																																				
WIRE FEEDER 2	ABSENT																																				
REMOTE CONTROL 2	RC OPTIONAL																																				
TORCH TYPE 2	400A H2O																																				
SAFETY CALIBRATION CODE 2	013																																				
<p>TORCH TYPE 1 / TORCH TYPE 2</p>  <table border="1" data-bbox="204 689 432 815"> <tr><td>WATER COOLER</td><td>OPTIONAL</td></tr> <tr><td>WIRE FEEDER 1</td><td>OPTIONAL</td></tr> <tr><td>REMOTE CONTROL 1</td><td>OPTIONAL</td></tr> <tr><td>TORCH TYPE 1</td><td>400A H2O</td></tr> <tr><td>SAFETY CALIBRATION CODE 1</td><td>013</td></tr> <tr><td>WIRE FEEDER 2</td><td>ABSENT</td></tr> <tr><td>REMOTE CONTROL 2</td><td>RC OPTIONAL</td></tr> <tr><td>TORCH TYPE 2</td><td>400A H2O</td></tr> <tr><td>SAFETY CALIBRATION CODE 2</td><td>013</td></tr> </table>  <table border="1" data-bbox="204 869 432 994"> <tr><td>WATER COOLER</td><td>OPTIONAL</td></tr> <tr><td>WIRE FEEDER 1</td><td>OPTIONAL</td></tr> <tr><td>REMOTE CONTROL 1</td><td>OPTIONAL</td></tr> <tr><td>TORCH TYPE 1</td><td>400A H2O</td></tr> <tr><td>SAFETY CALIBRATION CODE 1</td><td>013</td></tr> <tr><td>WIRE FEEDER 2</td><td>ABSENT</td></tr> <tr><td>REMOTE CONTROL 2</td><td>RC OPTIONAL</td></tr> <tr><td>TORCH TYPE 2</td><td>400A H2O</td></tr> <tr><td>SAFETY CALIBRATION CODE 2</td><td>013</td></tr> </table>	WATER COOLER	OPTIONAL	WIRE FEEDER 1	OPTIONAL	REMOTE CONTROL 1	OPTIONAL	TORCH TYPE 1	400A H2O	SAFETY CALIBRATION CODE 1	013	WIRE FEEDER 2	ABSENT	REMOTE CONTROL 2	RC OPTIONAL	TORCH TYPE 2	400A H2O	SAFETY CALIBRATION CODE 2	013	WATER COOLER	OPTIONAL	WIRE FEEDER 1	OPTIONAL	REMOTE CONTROL 1	OPTIONAL	TORCH TYPE 1	400A H2O	SAFETY CALIBRATION CODE 1	013	WIRE FEEDER 2	ABSENT	REMOTE CONTROL 2	RC OPTIONAL	TORCH TYPE 2	400A H2O	SAFETY CALIBRATION CODE 2	013	<p>Used to set the TORCH TYPE 1/2 that will subsequently be connected to the welding plant. This operation must be done in order to size the plant correctly and as a result, the welding parameters.</p>
WATER COOLER	OPTIONAL																																				
WIRE FEEDER 1	OPTIONAL																																				
REMOTE CONTROL 1	OPTIONAL																																				
TORCH TYPE 1	400A H2O																																				
SAFETY CALIBRATION CODE 1	013																																				
WIRE FEEDER 2	ABSENT																																				
REMOTE CONTROL 2	RC OPTIONAL																																				
TORCH TYPE 2	400A H2O																																				
SAFETY CALIBRATION CODE 2	013																																				
WATER COOLER	OPTIONAL																																				
WIRE FEEDER 1	OPTIONAL																																				
REMOTE CONTROL 1	OPTIONAL																																				
TORCH TYPE 1	400A H2O																																				
SAFETY CALIBRATION CODE 1	013																																				
WIRE FEEDER 2	ABSENT																																				
REMOTE CONTROL 2	RC OPTIONAL																																				
TORCH TYPE 2	400A H2O																																				
SAFETY CALIBRATION CODE 2	013																																				
<p>SAFETY CALIBRATION CODE 1 / SAFETY CALIBRATION CODE 2</p>  <table border="1" data-bbox="204 1137 432 1263"> <tr><td>WATER COOLER</td><td>OPTIONAL</td></tr> <tr><td>WIRE FEEDER 1</td><td>OPTIONAL</td></tr> <tr><td>REMOTE CONTROL 1</td><td>RC OPTIONAL</td></tr> <tr><td>TORCH TYPE 1</td><td>400A H2O</td></tr> <tr><td>SAFETY CALIBRATION CODE 1</td><td>CALIBRATION</td></tr> <tr><td>WIRE FEEDER 2</td><td>ABSENT</td></tr> <tr><td>REMOTE CONTROL 2</td><td>RC OPTIONAL</td></tr> <tr><td>TORCH TYPE 2</td><td>400A H2O</td></tr> <tr><td>SAFETY CALIBRATION CODE 2</td><td>CALIBRATION</td></tr> </table>  <table border="1" data-bbox="204 1317 432 1442"> <tr><td>WATER COOLER</td><td>OPTIONAL</td></tr> <tr><td>WIRE FEEDER 1</td><td>OPTIONAL</td></tr> <tr><td>REMOTE CONTROL 1</td><td>RC OPTIONAL</td></tr> <tr><td>TORCH TYPE 1</td><td>400A H2O</td></tr> <tr><td>SAFETY CALIBRATION CODE 1</td><td>CALIBRATION</td></tr> <tr><td>WIRE FEEDER 2</td><td>ABSENT</td></tr> <tr><td>REMOTE CONTROL 2</td><td>RC OPTIONAL</td></tr> <tr><td>TORCH TYPE 2</td><td>400A H2O</td></tr> <tr><td>SAFETY CALIBRATION CODE 2</td><td>CALIBRATION</td></tr> </table>	WATER COOLER	OPTIONAL	WIRE FEEDER 1	OPTIONAL	REMOTE CONTROL 1	RC OPTIONAL	TORCH TYPE 1	400A H2O	SAFETY CALIBRATION CODE 1	CALIBRATION	WIRE FEEDER 2	ABSENT	REMOTE CONTROL 2	RC OPTIONAL	TORCH TYPE 2	400A H2O	SAFETY CALIBRATION CODE 2	CALIBRATION	WATER COOLER	OPTIONAL	WIRE FEEDER 1	OPTIONAL	REMOTE CONTROL 1	RC OPTIONAL	TORCH TYPE 1	400A H2O	SAFETY CALIBRATION CODE 1	CALIBRATION	WIRE FEEDER 2	ABSENT	REMOTE CONTROL 2	RC OPTIONAL	TORCH TYPE 2	400A H2O	SAFETY CALIBRATION CODE 2	CALIBRATION	<p>By turning <b>ENCODER K<sub>NOB</sub> - DX</b>, go to CALIBRATION value to read and check instruments values (voltmeter and ammeter) of the power source.</p> <p><b>NOTE:</b> At the end of such operation, before restarting welding, you should put back the previous value by always turning the <b>ENCODER K<sub>NOB</sub> - DX</b>.</p>
WATER COOLER	OPTIONAL																																				
WIRE FEEDER 1	OPTIONAL																																				
REMOTE CONTROL 1	RC OPTIONAL																																				
TORCH TYPE 1	400A H2O																																				
SAFETY CALIBRATION CODE 1	CALIBRATION																																				
WIRE FEEDER 2	ABSENT																																				
REMOTE CONTROL 2	RC OPTIONAL																																				
TORCH TYPE 2	400A H2O																																				
SAFETY CALIBRATION CODE 2	CALIBRATION																																				
WATER COOLER	OPTIONAL																																				
WIRE FEEDER 1	OPTIONAL																																				
REMOTE CONTROL 1	RC OPTIONAL																																				
TORCH TYPE 1	400A H2O																																				
SAFETY CALIBRATION CODE 1	CALIBRATION																																				
WIRE FEEDER 2	ABSENT																																				
REMOTE CONTROL 2	RC OPTIONAL																																				
TORCH TYPE 2	400A H2O																																				
SAFETY CALIBRATION CODE 2	CALIBRATION																																				

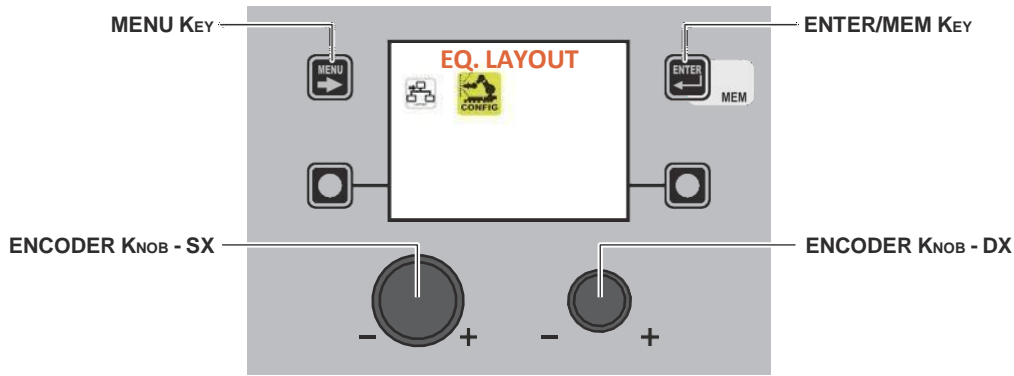

When in the *CONFIG menu*, rotate the **ENCODER KNOB - SX** to select activation of robot configuration.

**NOTE:** If robot configuration is activated when no robot interface is connected, an error message will be displayed, and it will not be possible to weld.

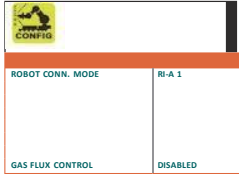
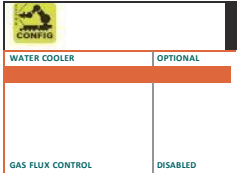
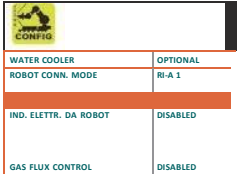
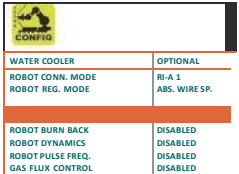
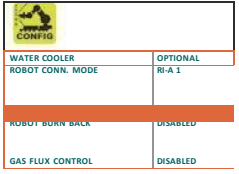
Advanced function	Description
<b>ROBOT WELDING</b> 	<p><b>DISABLED</b> - Means that manual welding is used.</p> <p><b>ENABLED</b> - Means that welding is enabled with the robot interface board. Once this function has been selected, the welding plant will require the robot interface board to be connected correctly. If this is not the case, an error message will be displayed and it will not be possible to weld.</p>
<b>ROBOT CONN. MODE (ROBOT CONNECTION MODE)</b> 	<p><b>RI-A 1</b> - Means that the presence of an interface board for analogue / digital type robots is detected</p> <p><b>RI-D 2</b> - Means that the presence of an interface board for Device net type robots is detected</p> <p>----- - Means that no type of robot board is detected</p>
<b>ROBOT REG. MODE (ROBOT REGULATION MODE)</b> 	<p><b>ASS. CURRENT</b> - In this mode, a MINIMUM ROBOT ANALOGUE V - MAXIMUM ROBOT ANALOGUE V (*) input corresponds to a current supplied of 0-500A.</p> <p><b>REL. CURRENT</b> - In this mode, a MINIMUM ROBOT ANALOGUE V - MAXIMUM ROBOT ANALOGUE V (*) input corresponds to extreme currents on the welding curve used.</p> <p><b>ASS. WIRE SPEED</b> - In this mode, a MINIMUM ROBOT ANALOGUE V - MAXIMUM ROBOT ANALOGUE V (*) input corresponds to a wire speed of 0-25 m/min.</p> <p><b>REL. WIRE SPEED</b> - In this mode, a MINIMUM ROBOT ANALOGUE V - MAXIMUM ROBOT ANALOGUE V (*) input corresponds to extreme wire speeds on the welding curve used.</p> <p>(*) These values can be set as described below.</p>
<b>ROBOT VOLTAGE</b> 	<p><b>NOT ACTIVE</b> - In this mode, regulation of the ARC LENGTH is active, via the welding machine's panel.</p> <p><b>ACTIVE</b> - In this mode, regulation of the ARC LENGTH is active, via the robot interface board.</p>
<b>ROBOT ELECTRONIC INDUCTANCE</b> 	<p><b>NOT ACTIVE</b> - In this mode, regulation of the ELECTRONIC INDUCTANCE is active, via the welding machine's panel.</p> <p><b>ACTIVE</b> - In this mode, regulation of the ELECTRONIC INDUCTANCE is active, via the robot interface board.</p>

(continua)

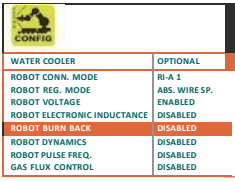
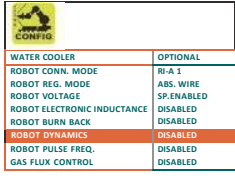
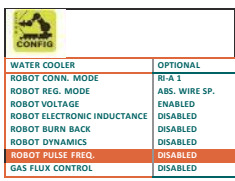
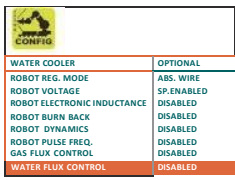
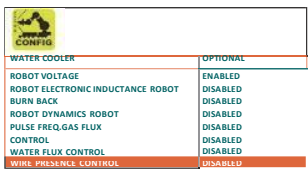
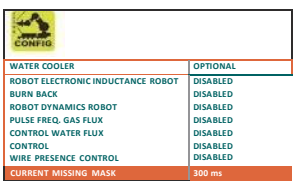
Advanced function	Description
<p><b>ROBOT BURN BACK</b></p> 	<p>NOT ACTIVE - In this mode, regulation of the BURN BACK is active, via the welding machine's panel.</p> <p>ACTIVE - In this mode, regulation of the BURN BACK is active, via the robot interface board.</p>
<p><b>ROBOT DYNAMICS</b></p> 	<p>NOT ACTIVE - In this mode, DYNAMIC regulation is active, via the welding machine's panel.</p> <p>ACTIVE - In this mode, DYNAMIC regulation is active, via the robot interface board.</p>
<p><b>ROBOT PULSE FREQ. (ROBOT PULSE FREQUENCY)</b></p> 	<p>NOT ACTIVE - In this mode, PULSATION FREQUENCY regulation is active, via the welding machine's panel.</p> <p>ACTIVE - In this mode, PULSATION FREQUENCY regulation is active, via the robot interface board.</p>
<p><b>GAS FLUX CONTROL</b></p> 	<p>NOT ACTIVE - In this mode the GAS FLOW input for the MCB-3 motor control box is ignored.</p> <p>ACTIVE - In this mode the GAS FLOW input for the MCB-3 motor control box is checked, and if necessary the relevant alarm is activated.</p>
<p><b>WATER FLUX CONTROL</b></p> 	<p>NOT ACTIVE - In this mode the WATER FLOW input for the MCB-3 motor control box is ignored.</p> <p>ACTIVE - In this mode the WATER FLOW input for the MCB-3 motor control box is tested, and if necessary the relevant WATER FAULT alarm is activated via the output of the box.</p>
<p><b>WIRE PRESENCE CONTROL</b></p> 	<p>NOT ACTIVE - In this mode the WIRE PRESENCE input for the MCB-3 motor control box is ignored.</p> <p>ACTIVE - In this mode the WIRE PRESENCE input for the MCB-3 motor control box is tested, and if necessary the relevant WIRE MISSING alarm is activated via the robot interface board.</p>
<p><b>CURRENT MISSING MASK</b></p> 	<p>XXX [ms] - During and on completion of welding, this indicates the time lapse between current zeroing and deactivation of the CURRENT SENSE digital output on the robot interface board.</p>

(continua)

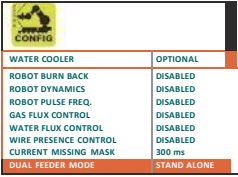
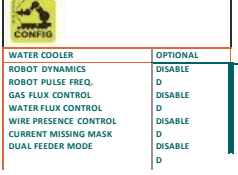
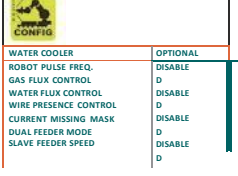
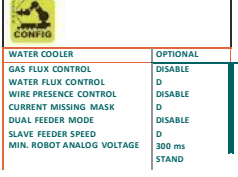
Advanced function	Description
<p><b>DUAL FEEDER MODE</b></p> 	<p><b>SEPARATE</b> - If a double feeder is chosen in the EQUIPMENT LAYOUT menu, in this mode the second feeder operates separately from the first.</p> <p><b>SLAVED</b> - If a double feeder is chosen in the EQUIPMENT LAYOUT menu, in this mode the second feeder operates simultaneously with and parallel to the first.</p>
<p><b>SLAVE FEEDER SPEED</b></p> 	<p>The parameter indicates the speed difference in % for the slave feeder, compared to the main feeder.</p>
<p><b>MIN. ROBOT ANALOG VOLTAGE</b></p>  <p><b>MAX. ROBOT ANALOG VOLTAGE</b></p> 	<p>These parameters are used to set the maximum and minimum voltage settings used to control the robot board's analogue inputs.</p> <p>The settable values are:  <b>MINIMUM ROBOT ANALOGUE V</b> from 0V to 2V  <b>MAXIMUM ROBOT ANALOGUE V</b> from 5V to 14,5V</p>

To exit the *EQUIPMENT LAYOUT Menu* and go back to the *ADVANCED SETUP Menu*:

- Push the **MENU KEY**.

The purpose of this menu is to allow the operator to know the latest welding parameters set on the machine, as well as the latest data saved on the machine.

To access the *WELD LOG Menu* from the *ADVANCED SETUP Menu*:

- Turn the **ENCODER KNOB - SX** to select the desired icon.
- Push the **ENTER/MEM KEY**.

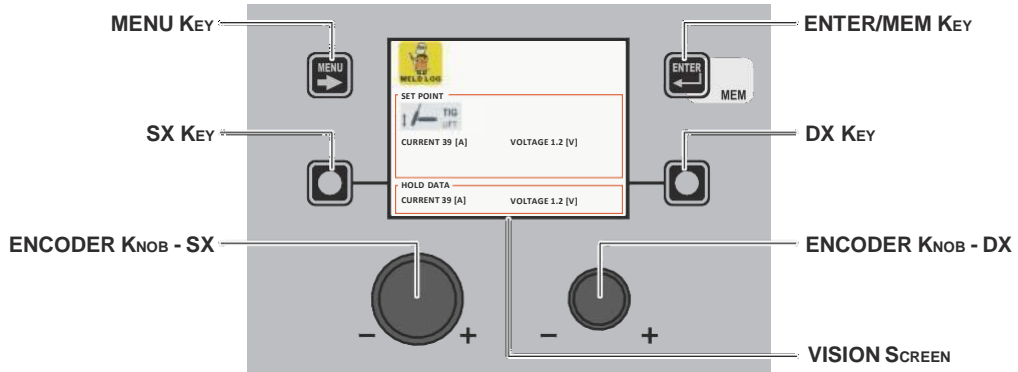

The content of this menu is for information only, the operator cannot make any changes, they can only read the information available on the screen.

To exit the *WELD LOG Menu* and go back to the *ADVANCED SETUP Menu*:

- Push the **MENU KEY**.





# PowerTech Series



**GeKaMac**<sup>®</sup>



**Gedik Welding Inc.**

Ankara Caddesi No: 306 Şeyhli 34906 Pendik - İstanbul / Turkey

**P.** +90 216 378 50 00 • **F.** +90 216 378 20 44

[www.gedikwelding.com](http://www.gedikwelding.com)